

रोल नं.

Roll No.



प्रश्न-पत्र कोड
Q.P. Code

55/1/2

परीक्षार्थी प्रश्न-पत्र कोड को उत्तर-पुस्तिका के मुख-पृष्ठ पर अवश्य लिखें।

Candidates must write the Q.P. Code on the title page of the answer-book.

भौतिक विज्ञान (सैद्धान्तिक)

PHYSICS (Theory)

निर्धारित समय : 3 घण्टे

अधिकतम अंक : 70

Time allowed : 3 hours

Maximum Marks : 70

नोट	NOTE
(I) कृपया जाँच कर लें कि इस प्रश्न-पत्र में मुद्रित पृष्ठ 27 हैं।	(I) Please check that this question paper contains 27 printed pages.
(II) कृपया जाँच कर लें कि इस प्रश्न-पत्र में 33 प्रश्न हैं।	(II) Please check that this question paper contains 33 questions.
(III) प्रश्न-पत्र में दाहिने हाथ की ओर दिए गए प्रश्न-पत्र कोड को परीक्षार्थी उत्तर-पुस्तिका के मुख-पृष्ठ पर लिखें।	(III) Q.P. Code given on the right hand side of the question paper should be written on the title page of the answer-book by the candidate.
(IV) कृपया प्रश्न का उत्तर लिखना शुरू करने से पहले, उत्तर-पुस्तिका में प्रश्न का क्रमांक अवश्य लिखें।	(IV) Please write down the serial number of the question in the answer-book before attempting it.
(V) इस प्रश्न-पत्र को पढ़ने के लिए 15 मिनट का समय दिया गया है। प्रश्न-पत्र का वितरण पूर्वाह्न में 10.15 बजे किया जाएगा। 10.15 बजे से 10.30 बजे तक छात्र केवल प्रश्न-पत्र को पढ़ेंगे और इस अवधि के दौरान वे उत्तर-पुस्तिका पर कोई उत्तर नहीं लिखेंगे।	(V) 15 minute time has been allotted to read this question paper. The question paper will be distributed at 10.15 a.m. From 10.15 a.m. to 10.30 a.m., the students will read the question paper only and will not write any answer on the answer-book during this period.

सामान्य निर्देश:

निम्नलिखित निर्देशों को ध्यानपूर्वक पढ़िए और उनका पालन कीजिए :

- (i) इस प्रश्न-पत्र में 33 प्रश्न हैं। सभी प्रश्न अनिवार्य हैं।
- (ii) यह प्रश्न-पत्र पाँच खण्डों में विभाजित है – खण्ड क, ख, ग, घ एवं ङ।
- (iii) खण्ड क में प्रश्न संख्या 1 से 16 तक बहुविकल्पीय प्रकार के प्रश्न हैं। प्रत्येक प्रश्न 1 अंक का है।
- (iv) खण्ड ख में प्रश्न संख्या 17 से 21 तक अति लघु-उत्तरीय प्रकार के प्रश्न हैं। प्रत्येक प्रश्न 2 अंकों का है।
- (v) खण्ड ग में प्रश्न संख्या 22 से 28 तक लघु-उत्तरीय प्रकार के प्रश्न हैं। प्रत्येक प्रश्न 3 अंकों का है।
- (vi) खण्ड घ में प्रश्न संख्या 29 तथा 30 केस अध्ययन-आधारित प्रश्न हैं। प्रत्येक प्रश्न 4 अंकों का है।
- (vii) खण्ड ङ में प्रश्न संख्या 31 से 33 तक दीर्घ-उत्तरीय प्रकार के प्रश्न हैं। प्रत्येक प्रश्न 5 अंकों का है।
- (viii) प्रश्न-पत्र में समग्र विकल्प नहीं दिया गया है। यद्यपि, खण्ड क के अतिरिक्त अन्य खण्डों के कुछ प्रश्नों में आंतरिक विकल्प का चयन दिया गया है।
- (ix) ध्यान दें कि दृष्टिबाधित परीक्षार्थियों के लिए एक अलग प्रश्न-पत्र है।
- (x) कैल्कुलेटर का उपयोग वर्जित है।

जहाँ आवश्यक हो, आप निम्नलिखित भौतिक नियतांकों के मानों का उपयोग कर सकते हैं :

$$c = 3 \times 10^8 \text{ m/s}$$

$$h = 6.63 \times 10^{-34} \text{ Js}$$

$$e = 1.6 \times 10^{-19} \text{ C}$$

$$\mu_0 = 4\pi \times 10^{-7} \text{ T m A}^{-1}$$

$$\epsilon_0 = 8.854 \times 10^{-12} \text{ C}^2 \text{ N}^{-1} \text{ m}^{-2}$$

$$\frac{1}{4\pi\epsilon_0} = 9 \times 10^9 \text{ N m}^2 \text{ C}^{-2}$$

$$\text{इलेक्ट्रॉन का द्रव्यमान (m}_e\text{)} = 9.1 \times 10^{-31} \text{ kg}$$

$$\text{न्यूट्रॉन का द्रव्यमान} = 1.675 \times 10^{-27} \text{ kg}$$

$$\text{प्रोटॉन का द्रव्यमान} = 1.673 \times 10^{-27} \text{ kg}$$

$$\text{आवोगाद्रो संख्या} = 6.023 \times 10^{23} \text{ प्रति ग्राम मोल}$$

$$\text{बोल्ट्ज़मान नियतांक} = 1.38 \times 10^{-23} \text{ JK}^{-1}$$

General Instructions :

Read the following instructions carefully and follow them :

- (i) This question paper contains **33** questions. **All** questions are **compulsory**.
- (ii) This question paper is divided into **five** sections – **Sections A, B, C, D and E**.
- (iii) In **Section A** – Questions no. **1 to 16** are Multiple Choice type questions. Each question carries **1** mark.
- (iv) In **Section B** – Questions no. **17 to 21** are Very Short Answer type questions. Each question carries **2** marks.
- (v) In **Section C** – Questions no. **22 to 28** are Short Answer type questions. Each question carries **3** marks.
- (vi) In **Section D** – Questions no. **29 and 30** are case study-based questions. Each question carries **4** marks.
- (vii) In **Section E** – Questions no. **31 to 33** are Long Answer type questions. Each question carries **5** marks.
- (viii) There is no overall choice given in the question paper. However, an internal choice has been provided in few questions in all the Sections except Section A.
- (ix) Kindly note that there is a separate question paper for Visually Impaired candidates.
- (x) Use of calculators is **not** allowed.

You may use the following values of physical constants wherever necessary :

$$c = 3 \times 10^8 \text{ m/s}$$

$$h = 6.63 \times 10^{-34} \text{ Js}$$

$$e = 1.6 \times 10^{-19} \text{ C}$$

$$\mu_0 = 4\pi \times 10^{-7} \text{ T m A}^{-1}$$

$$\epsilon_0 = 8.854 \times 10^{-12} \text{ C}^2 \text{ N}^{-1} \text{ m}^{-2}$$

$$\frac{1}{4\pi\epsilon_0} = 9 \times 10^9 \text{ N m}^2 \text{ C}^{-2}$$

$$\text{Mass of electron } (m_e) = 9.1 \times 10^{-31} \text{ kg}$$

$$\text{Mass of neutron} = 1.675 \times 10^{-27} \text{ kg}$$

$$\text{Mass of proton} = 1.673 \times 10^{-27} \text{ kg}$$

$$\text{Avogadro's number} = 6.023 \times 10^{23} \text{ per gram mole}$$

$$\text{Boltzmann constant} = 1.38 \times 10^{-23} \text{ JK}^{-1}$$

खण्ड क

1. किसी पतली प्लास्टिक की छड़ को त्रिज्या R के वृत्ताकार वलय के रूप में मोड़ा गया है। इसे आवेश घनत्व λ से एकसमान आवेशित किया गया है। इसके केन्द्र पर विद्युत-क्षेत्र का परिमाण है :

(A) $\frac{\lambda}{2\epsilon_0 R}$ (B) शून्य (C) $\frac{\lambda}{4\pi\epsilon_0 R}$ (D) $\frac{\lambda}{4\epsilon_0 R}$
2. त्रिज्या r के किसी आवेशित गोले का पृष्ठीय आवेश घनत्व σ है। इसके पृष्ठ पर विद्युत-क्षेत्र E है। यदि आवेश घनत्व समान रखते हुए गोले की त्रिज्या दुगुनी कर दी जाए, तो पुराने गोले और नए गोले के विद्युत-क्षेत्रों का अनुपात होगा :

(A) 1 (B) $\frac{1}{2}$ (C) $\frac{1}{4}$ (D) 4
3. किसी छात्र से चार सेलों, जिनमें प्रत्येक का वि.वा. बल (emf) E तथा आन्तरिक प्रतिरोध r है, को श्रेणी में संयोजित करने के लिए कहा गया है। परन्तु वह इनमें से एक सेल को अन्य सेलों के साथ गलत ढंग से श्रेणी में संयोजित करता/करती है। संयोजन के तुल्य वि.वा. बल (emf) और तुल्य आन्तरिक प्रतिरोध होंगे क्रमशः

(A) $4E$ और $2r$ (B) $4E$ और $3r$
 (C) $3E$ और $4r$ (D) $2E$ और $4r$
4. किसी तार के टुकड़े को वृत्ताकार पाश A में मोड़ा गया है और उससे I धारा प्रवाहित हो रही है। तार को फिर दो फेरों के वृत्ताकार पाश B में मोड़ा गया और उससे समान धारा प्रवाहित की गई। पाश A और पाश B के केन्द्रों पर चुम्बकीय क्षेत्रों का अनुपात होगा :

(A) $\frac{1}{16}$ (B) 16
 (C) 4 (D) $\frac{1}{4}$
5. कोई 10 cm लम्बा तार y -अक्ष के अनुदिश रखा है। इससे धनात्मक y -दिशा में 1.0 A की धारा प्रवाहित हो रही है। इस क्षेत्र में कोई चुम्बकीय क्षेत्र $\vec{B} = (5 \text{ mT})\hat{j} - (8 \text{ mT})\hat{k}$ विद्यमान है। इस तार पर बल है :

(A) $(0.8 \text{ mN})\hat{i}$ (B) $-(0.8 \text{ mN})\hat{i}$
 (C) $(80 \text{ mN})\hat{i}$ (D) $-(80 \text{ mN})\hat{i}$

SECTION A

1. A thin plastic rod is bent into a circular ring of radius R . It is uniformly charged with charge density λ . The magnitude of the electric field at its centre is :
- (A) $\frac{\lambda}{2\epsilon_0 R}$ (B) Zero (C) $\frac{\lambda}{4\pi\epsilon_0 R}$ (D) $\frac{\lambda}{4\epsilon_0 R}$
2. A charged sphere of radius r has surface charge density σ . The electric field on its surface is E . If the radius of the sphere is doubled, keeping charge density the same, the ratio of the electric field on the old sphere to that on the new sphere will be :
- (A) 1 (B) $\frac{1}{2}$ (C) $\frac{1}{4}$ (D) 4
3. A student is asked to connect four cells, each of emf E and internal resistance r , in series. But she/he connects one cell wrongly in series with the other cells. The equivalent emf and the equivalent internal resistance of the combination will be :
- (A) $4E$ and $2r$ (B) $4E$ and $3r$
(C) $3E$ and $4r$ (D) $2E$ and $4r$
4. A piece of wire bent in the form of a circular loop A carries a current I . The wire is then bent into a circular loop B of two turns and carries the same current. The ratio of magnetic fields at the centre of loop A to that of loop B will be :
- (A) $\frac{1}{16}$ (B) 16
(C) 4 (D) $\frac{1}{4}$
5. A 10 cm long wire lies along y -axis. It carries a current of 1.0 A in positive y -direction. A magnetic field $\vec{B} = (5 \text{ mT})\hat{j} - (8 \text{ mT})\hat{k}$ exists in the region. The force on the wire is :
- (A) $(0.8 \text{ mN})\hat{i}$ (B) $-(0.8 \text{ mN})\hat{i}$
(C) $(80 \text{ mN})\hat{i}$ (D) $-(80 \text{ mN})\hat{i}$



6. प्रतिरोध $G \Omega$ के किसी गैल्वेनोमीटर को 0 से 1 A परिसर के ऐमीटर में परिवर्तित किया गया है। यदि इस गैल्वेनोमीटर में प्रवाहित धारा 1 A की 0.1% है, तो ऐमीटर का प्रतिरोध है :
- (A) $\frac{G}{999} \Omega$ (B) $\frac{G}{1000} \Omega$ (C) $\frac{G}{1001} \Omega$ (D) $\frac{G}{100-1} \Omega$
7. कोई चालक वृत्ताकार पाश किसी एकसमान चुम्बकीय क्षेत्र $B = 50 \text{ mT}$ में चुम्बकीय क्षेत्र के समतल लम्बवत् स्थित है। पाश की त्रिज्या 1 mm s^{-1} की एकसमान दर से सिकुड़ने लगती है। जिस क्षण पाश की त्रिज्या 4 cm है, तब पाश में प्रेरित वि.वा. बल (emf) है :
- (A) $\pi \mu\text{V}$ (B) $2\pi \mu\text{V}$
(C) $4\pi \mu\text{V}$ (D) $8\pi \mu\text{V}$
8. किसी विद्युत-चुम्बकीय तरंग के विद्युत और चुम्बकीय क्षेत्र :
- (A) एक-दूसरे के लम्बवत् और समान कला में होते हैं।
(B) एक-दूसरे के लम्बवत् नहीं होते और समान कला में होते हैं।
(C) एक-दूसरे के लम्बवत् होते हैं लेकिन समान कला में नहीं होते हैं।
(D) न तो एक-दूसरे के लम्बवत् और न ही समान कला में होते हैं।
9. दो पुंज, A और B जिनके फोटॉनों की ऊर्जा क्रमशः 3.3 eV और 11.3 eV हैं, क्रमवार किसी धात्विक पृष्ठ (कार्य-फलन 2.3 eV) को प्रदीप्त करते हैं। पुंज A के कारण उत्सर्जित इलेक्ट्रॉनों की अधिकतम चाल का पुंज B के कारण उत्सर्जित इलेक्ट्रॉनों की अधिकतम चाल से अनुपात है :
- (A) 3 (B) 9 (C) $\frac{1}{3}$ (D) $\frac{1}{9}$
10. किसी गतिमान इलेक्ट्रॉन और किसी गतिमान प्रोटॉन से सम्बद्ध तरंगों का तरंगदैर्घ्य λ समान है। इसका यह अभिप्राय है कि इनका/इनकी समान है :
- (A) संवेग (B) कोणीय संवेग
(C) चाल (D) ऊर्जा
11. Ge का मादन As के साथ किया गया है। इसके कारण :
- (A) Ge के जालक की संरचना विकृत हो जाती है।
(B) चालन इलेक्ट्रॉनों की संख्या में वृद्धि होती है।
(C) होलों की संख्या में वृद्धि होती है।
(D) चालन इलेक्ट्रॉनों की संख्या में हास होता है।



6. A galvanometer of resistance $G \Omega$ is converted into an ammeter of range 0 to I A. If the current through the galvanometer is 0.1% of I A, the resistance of the ammeter is :
- (A) $\frac{G}{999} \Omega$ (B) $\frac{G}{1000} \Omega$ (C) $\frac{G}{1001} \Omega$ (D) $\frac{G}{100.1} \Omega$
7. A conducting circular loop is placed in a uniform magnetic field $B = 50$ mT with its plane perpendicular to the magnetic field. The radius of the loop is made to shrink at a constant rate of 1 mm s^{-1} . At the instant the radius of the loop is 4 cm, the induced emf in the loop is :
- (A) $\pi \mu\text{V}$ (B) $2\pi \mu\text{V}$
 (C) $4\pi \mu\text{V}$ (D) $8\pi \mu\text{V}$
8. The electric and magnetic fields of electromagnetic waves are :
- (A) In the same phase and perpendicular to each other.
 (B) In the same phase and not perpendicular to each other.
 (C) Not in the same phase but are perpendicular to each other.
 (D) Neither in the same phase nor perpendicular to each other.
9. Two beams, A and B whose photon energies are 3.3 eV and 11.3 eV respectively, illuminate a metallic surface (work function 2.3 eV) successively. The ratio of maximum speed of electrons emitted due to beam A to that due to beam B is :
- (A) 3 (B) 9 (C) $\frac{1}{3}$ (D) $\frac{1}{9}$
10. The waves associated with a moving electron and a moving proton have the same wavelength λ . It implies that they have the same :
- (A) momentum (B) angular momentum
 (C) speed (D) energy
11. Ge is doped with As. Due to doping,
- (A) the structure of Ge lattice is distorted.
 (B) the number of conduction electrons increases.
 (C) the number of holes increases.
 (D) the number of conduction electrons decreases.



12. इलेक्ट्रॉन का वह संक्रमण, जिसके द्वारा हाइड्रोजन परमाणु के स्पेक्ट्रम में बामर श्रेणी की दूसरी स्पेक्ट्रमी रेखा प्राप्त होती है, संगत होता है :

(A) $n_f = 2$ तथा $n_i = 3$

(B) $n_f = 3$ तथा $n_i = 4$

(C) $n_f = 2$ तथा $n_i = 4$

(D) $n_f = 2$ तथा $n_i = \infty$

प्रश्न संख्या 13 से 16 अभिकथन (A) और कारण (R) प्रकार के प्रश्न हैं। दो कथन दिए गए हैं — जिनमें एक को अभिकथन (A) तथा दूसरे को कारण (R) द्वारा अंकित किया गया है। सही उत्तर नीचे दिए गए कोडों (A), (B), (C) और (D) में से चुनकर दीजिए।

(A) अभिकथन (A) और कारण (R) दोनों सही हैं और कारण (R), अभिकथन (A) की सही व्याख्या करता है।

(B) अभिकथन (A) और कारण (R) दोनों सही हैं, परन्तु कारण (R), अभिकथन (A) की सही व्याख्या नहीं करता है।

(C) अभिकथन (A) सही है, परन्तु कारण (R) ग़लत है।

(D) अभिकथन (A) ग़लत है तथा कारण (R) भी ग़लत है।

13. अभिकथन (A) : समतल दर्पण और उत्तल दर्पण किसी भी परिस्थिति में वास्तविक प्रतिबिम्ब नहीं बना सकते हैं।

कारण (R) : कोई आभासी प्रतिबिम्ब वास्तविक प्रतिबिम्ब बनाने के लिए बिम्ब की भाँति कार्य नहीं कर सकता है।

14. अभिकथन (A) : किसी बैटरी से श्रेणी में संयोजित और स्वतंत्रतापूर्वक निलंबित दो लंबे समान्तर तार एक-दूसरे से दूर हटते हैं।

कारण (R) : विपरीत दिशाओं में प्रवाहित धारावाही दो तार एक-दूसरे को प्रतिकर्षित करते हैं।

15. अभिकथन (A) : प्रकाश-विद्युत प्रभाव में, उत्सर्जित फोटो-इलेक्ट्रॉनों की गतिज ऊर्जा में आपतित प्रकाश की तीव्रता में वृद्धि के साथ वृद्धि होती है।

कारण (R) : प्रकाश-विद्युत धारा आपतित प्रकाश की तरंगदैर्घ्य पर निर्भर करती है।

16. अभिकथन (A) : जब दो कुण्डलियों को एक-दूसरे के ऊपर लपेटा जाता है, तो उनके बीच अन्योन्य प्रेरकत्व अधिकतम होता है।

कारण (R) : जब दो कुण्डलियाँ एक-दूसरे पर लिपटी होती हैं, तब उनके बीच फ्लक्स संबद्धता अधिकतम होती है।

12. The transition of electron that gives rise to the formation of the second spectral line of the Balmer series in the spectrum of hydrogen atom corresponds to :
- (A) $n_f = 2$ and $n_i = 3$ (B) $n_f = 3$ and $n_i = 4$
(C) $n_f = 2$ and $n_i = 4$ (D) $n_f = 2$ and $n_i = \infty$

Questions number 13 to 16 are Assertion (A) and Reason (R) type questions. Two statements are given — one labelled Assertion (A) and the other labelled Reason (R). Select the correct answer from the codes (A), (B), (C) and (D) as given below.

- (A) Both Assertion (A) and Reason (R) are true and Reason (R) is the correct explanation of the Assertion (A).
(B) Both Assertion (A) and Reason (R) are true, but Reason (R) is **not** the correct explanation of the Assertion (A).
(C) Assertion (A) is true, but Reason (R) is false.
(D) Assertion (A) is false and Reason (R) is also false.
13. *Assertion (A)* : Plane and convex mirrors cannot produce real images under any circumstance.
Reason (R) : A virtual image cannot serve as an object to produce a real image.
14. *Assertion (A)* : Two long parallel wires, freely suspended and connected in series to a battery, move apart.
Reason (R) : Two wires carrying current in opposite directions repel each other.
15. *Assertion (A)* : In photoelectric effect, the kinetic energy of the emitted photoelectrons increases with increase in the intensity of the incident light.
Reason (R) : Photoelectric current depends on the wavelength of the incident light.
16. *Assertion (A)* : The mutual inductance between two coils is maximum when the coils are wound on each other.
Reason (R) : The flux linkage between two coils is maximum when they are wound on each other.



खण्ड ख

17. आरेख में दर्शाए अनुसार दो बैटरियाँ जिनके वि.वा. बल (emf) 6 V और 3 V हैं तथा आन्तरिक प्रतिरोध क्रमशः 0.8 Ω और 0.2 Ω हैं, किसी बाह्य प्रतिरोध R से श्रेणी में संयोजित हैं। R का वह मान ज्ञात कीजिए ताकि 6 V की बैटरी के सिरोँ पर विभवान्तर शून्य हो।

2

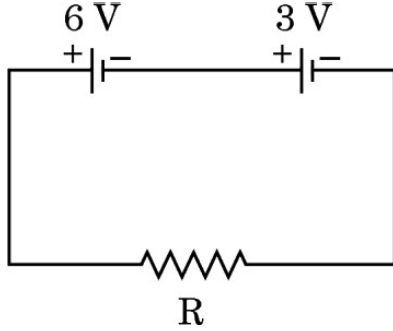

18. गतिज ऊर्जा E के किसी न्यूट्रॉन (द्रव्यमान m) तथा समान ऊर्जा के किसी फोटॉन पर विचार कीजिए। मान लीजिए न्यूट्रॉन की दे ब्रॉग्ली तरंगदैर्घ्य λ_n तथा फोटॉन की तरंगदैर्घ्य λ_p है। $\frac{\lambda_n}{\lambda_p}$ के लिए व्यंजक प्राप्त कीजिए।

2

19. (क) आवृत्ति 5.0×10^{14} Hz का एकवर्णी प्रकाश वायु से अपवर्तनांक 1.5 वाले माध्यम में गमन करता है। दोनों माध्यमों के अन्तरापृष्ठ पर (i) परावर्तित प्रकाश, तथा (ii) अपवर्तित प्रकाश की तरंगदैर्घ्य ज्ञात कीजिए।

2

अथवा

- (ख) 16 cm फोकस दूरी का कोई समतलोत्तल लेंस अपवर्तनांक 1.4 के पदार्थ का बना है। लेंस के वक्रित पृष्ठ की त्रिज्या परिकल्पित कीजिए।
20. कोई बिम्ब 40 cm वक्रता त्रिज्या के किसी अवतल दर्पण के सामने 30 cm दूरी पर स्थित है। (i) बने प्रतिबिम्ब की स्थिति तथा (ii) प्रतिबिम्ब का आवर्धन ज्ञात कीजिए।

2

2

21. किसी नैज अर्धचालक की चालकता ताप के साथ किस प्रकार परिवर्तित होती है ? व्याख्या कीजिए। विचरण को ग्राफ द्वारा दर्शाइए।

2

SECTION B

17. Two batteries of emfs 6 V and 3 V and internal resistances 0.8Ω and 0.2Ω respectively are connected in series to an external resistance R , as shown in figure. Find the value of R so that the potential difference across the 6 V battery be zero. 2

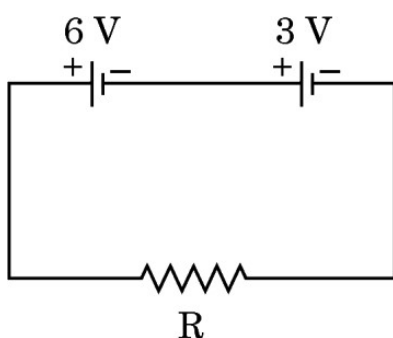

18. Consider a neutron (mass m) of kinetic energy E and a photon of the same energy. Let λ_n and λ_p be the de Broglie wavelength of neutron and the wavelength of photon respectively. Obtain an expression for $\frac{\lambda_n}{\lambda_p}$. 2
19. (a) Monochromatic light of frequency 5.0×10^{14} Hz passes from air into a medium of refractive index 1.5. Find the wavelength of the light (i) reflected, and (ii) refracted at the interface of the two media. 2
- OR**
- (b) A plano-convex lens of focal length 16 cm is made of a material of refractive index 1.4. Calculate the radius of the curved surface of the lens. 2
20. An object is placed 30 cm in front of a concave mirror of radius of curvature 40 cm. Find the (i) position of the image formed and (ii) magnification of the image. 2
21. How does the conductivity of an intrinsic semiconductor vary with temperature? Explain. Show the variation in a plot. 2

खण्ड ग

22. तीन बिन्दु आवेश Q_1 , Q_2 तथा Q_3 , $x - y$ तल में क्रमशः बिन्दुओं $(-d, 0)$, $(0, 0)$ और $(d, 0)$ पर स्थित हैं। Q_1 और Q_3 समरूप हैं तथा Q_2 धनात्मक है। आवेश Q_1 की प्रकृति और मान क्या हों ताकि इन आवेशों के निकाय की स्थितिज ऊर्जा शून्य हो ? 3

23. (क) 'धारा घनत्व' को परिभाषित कीजिए। क्या यह अदिश है या सदिश ? किसी धातु के चालक में कोई विद्युत-क्षेत्र \vec{E} बनाए रखा गया है। यदि इस चालक के प्रति एकांक आयतन में इलेक्ट्रॉनों (द्रव्यमान m , आवेश $-e$) की संख्या n है तथा इसका विश्रान्ति काल τ है, तो यह दर्शाइए कि धारा घनत्व $\vec{j} = \alpha \vec{E}$ है, जहाँ $\alpha = \left(\frac{ne^2}{m} \right) \tau$ है। 3

अथवा

(ख) व्हीटस्टोन सेतु किसे कहते हैं ? व्हीटस्टोन सेतु के संतुलन के लिए आवश्यक शर्तें प्राप्त कीजिए। 3

24. एक छड़ चुम्बक का चुम्बकीय आघूर्ण 2.5 JT^{-1} है। यह किसी 0.32 T के एकसमान चुम्बकीय क्षेत्र की दिशा में संरेखित रखा है।

(क) चुम्बक को घुमाने में किया गया कार्य ज्ञात कीजिए ताकि चुम्बकीय आघूर्ण को (i) क्षेत्र की दिशा के अभिलम्बवत्, तथा (ii) क्षेत्र की दिशा के विपरीत संरेखित किया जाए।

(ख) उपर्युक्त प्रकरण (i) और (ii) में चुम्बक पर बल-आघूर्ण क्या है ? 3

25. आरेख में दर्शाई गई दो कुण्डलियों P और Q के व्यवस्था पर विचार कीजिए। जब कुण्डली P में स्विच को खोलते या बन्द करते हैं, तो कुण्डली Q में भी धारा प्रवाहित होती है।

(क) इसमें निहित परिघटना की व्याख्या कीजिए।

(ख) उन दो कारकों का उल्लेख कीजिए जिन पर कुण्डली Q में उत्पन्न धारा निर्भर करती है।

(ग) कुण्डली Q में धारा की दिशा का उल्लेख कीजिए जब कुण्डली P में धारा प्रवाहित हो रही है तथा (i) R में वृद्धि होती है, तथा (ii) R में कमी होती है। 3

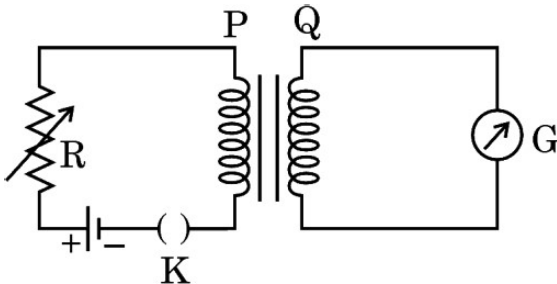

SECTION C

22. Three point charges Q_1 , Q_2 and Q_3 are located in $x - y$ plane at points $(-d, 0)$, $(0, 0)$ and $(d, 0)$ respectively. Q_1 and Q_3 are identical and Q_2 is positive. What will be the nature and value of Q_1 so that the potential energy of the system is zero ? 3

23. (a) Define 'current density'. Is it a scalar or a vector ? An electric field \vec{E} is maintained in a metallic conductor. If n be the number of electrons (mass m , charge $-e$) per unit volume in the conductor and τ its relaxation time, show that the current density $\vec{j} = \alpha \vec{E}$, where $\alpha = \left(\frac{ne^2}{m} \right) \tau$. 3

OR

(b) What is a Wheatstone bridge ? Obtain the necessary conditions under which the Wheatstone bridge is balanced. 3

24. A bar magnet of magnetic moment 2.5 JT^{-1} lies aligned with the direction of a uniform magnetic field of 0.32 T .

(a) Find the amount of work done to turn the magnet so as to align its magnetic moment (i) normal to the field direction, and (ii) opposite to the field direction.

(b) What is the torque on the magnet in above cases (i) and (ii) ? 3

25. Consider the arrangement of two coils P and Q shown in the figure. When current in coil P is switched on or switched off, a current flows in coil Q.

(a) Explain the phenomenon involved in it.

(b) Mention two factors on which the current produced in coil Q depends.

(c) Give the direction of current in coil Q when there is a current in the coil P and (i) R is increased, and (ii) R is decreased. 3

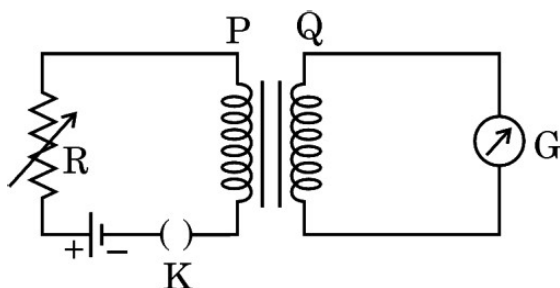

26. रदरफोर्ड के परमाणु मॉडल की कमियाँ लिखिए । बोर ने उन्हें किस प्रकार दूर किया ? यह दर्शाइए कि बोर परमाणु की विभिन्न कक्षाओं के बीच की दूरियाँ समान नहीं होती हैं । 3
27. (क) “विद्युत-चुम्बकीय तरंग की तरंगदैर्घ्य को प्रायः विकिरण उत्पन्न करने वाले निकाय के अभिलाक्षणिक साइज़ से संबंधित किया जाता है ।” इस कथन की पुष्टि के लिए दो उदाहरण दीजिए ।
- (ख) (i) लम्बी दूरियों के रेडियो प्रसारण के लिए लघु-तरंग बैंड का उपयोग किया जाता है । क्यों ?
- (ii) प्रकाशिक और रेडियो दूरबीन (दूरदर्शक) धरती पर स्थापित की जाती हैं, परन्तु X-किरण खगोलिकी केवल पृथ्वी की कक्षा में परिक्रमा करने वाले उपग्रहों से ही संभव है । क्यों ? 3
28. (क) नाभिकीय बल के दो अभिलाक्षणिक गुण लिखिए ।
- (ख) किसी न्यूक्लियॉनों के युगल की स्थितिज ऊर्जा और उनके पृथक्करण के बीच विचरण को ग्राफ खींचकर दर्शाइए । इस ग्राफ से निकाले जा सकने वाले दो महत्वपूर्ण निष्कर्ष लिखिए । 3

खण्ड घ

प्रश्न संख्या 29 तथा 30 केस अध्ययन-आधारित प्रश्न हैं । निम्नलिखित अनुच्छेदों को पढ़ कर नीचे दिए गए प्रश्नों के उत्तर दीजिए ।

29. संधि डायोड दिष्टकारी के रूप में :

ac वोल्टता को दिष्टकारी (dc) वोल्टता में परिवर्तित करने की प्रक्रिया को दिष्टकरण कहते हैं और इस परिवर्तन को सम्पन्न करने वाली युक्ति को दिष्टकारी कहते हैं । किसी p-n संधि डायोड के अभिलाक्षणिक से यह ज्ञात होता है कि जब p-n संधि डायोड अग्रदिशिक बायसित होता है, तो उसका प्रतिरोध निम्न होता है तथा जब पश्चदिशिक बायसित होता है, तो उसका प्रतिरोध उच्च होता है । इसका अर्थ यह है कि p-n संधि डायोड केवल अग्रदिशिक बायस होने पर ही चालन करता है । p-n संधि डायोड का यही गुण दिष्टकारी के रूप में इसके उपयोग के लिए इसे उपयुक्त बनाता है ।

इस प्रकार, जब किसी ac वोल्टता को किसी p-n संधि के सिरों पर अनुप्रयुक्त किया जाता है, तो यह केवल उन्हीं प्रत्यावर्ती अर्ध-चक्रों में चालन करती है जब यह अग्रदिशिक बायस होती है । वह दिष्टकारी जो किसी ac वोल्टता के अर्ध-चक्र का दिष्टकरण करता है, उसे अर्ध-तरंग दिष्टकारी कहते हैं और जो दोनों अर्ध-चक्रों का दिष्टकरण करता है, उसे पूर्ण-तरंग दिष्टकारी कहते हैं ।

26. Write the drawbacks of Rutherford's atomic model. How did Bohr remove them ? Show that different orbits in Bohr's atom are not equally spaced. 3
27. (a) "The wavelength of the electromagnetic wave is often correlated with the characteristic size of the system that radiates." Give two examples to justify this statement.
- (b) (i) Long distance radio broadcasts use short-wave bands. Why ?
(ii) Optical and radio telescopes are built on the ground, but X-ray astronomy is possible only from satellites orbiting the Earth. Why ? 3
28. (a) Write two characteristic properties of nuclear force.
- (b) Draw a plot of potential energy of a pair of nucleons as a function of their separation. Write two important conclusions that can be drawn from the plot. 3

SECTION D

Questions number 29 and 30 are case study-based questions. Read the following paragraphs and answer the questions that follow.

29. Junction Diode as a Rectifier :

The process of conversion of an ac voltage into a dc voltage is called rectification and the device which performs this conversion is called a rectifier. The characteristics of a p-n junction diode reveal that when a p-n junction diode is forward biased, it offers a low resistance and when it is reverse biased, it offers a high resistance. Hence, a p-n junction diode conducts only when it is forward biased. This property of a p-n junction diode makes it suitable for its use as a rectifier.

Thus, when an ac voltage is applied across a p-n junction, it conducts only during those alternate half cycles for which it is forward biased. A rectifier which rectifies only half cycle of an ac voltage is called a half-wave rectifier and one that rectifies both the half cycles is known as a full-wave rectifier.

- (i) किसी पूर्ण-तरंग दिष्टकारी पर अनुप्रयुक्त किसी प्रत्यावर्ती वोल्टता का वर्ग माध्य मूल मान $\frac{V_0}{\sqrt{2}}$ है। तो दिष्टीकृत निर्गत वोल्टता का वर्ग माध्य मूल मान है : 1
- (A) $\frac{V_0}{\sqrt{2}}$ (B) $\frac{V_0^2}{\sqrt{2}}$
- (C) $\frac{2V_0}{\sqrt{2}}$ (D) $\frac{V_0}{2\sqrt{2}}$
- (ii) किसी पूर्ण-तरंग दिष्टकारी में प्रत्येक डायोड से धारा प्रवाहित होती है : 1
- (A) निवेश सिग्नल के पूर्ण चक्र के लिए
- (B) निवेश सिग्नल के अर्ध-चक्र के लिए
- (C) निवेश सिग्नल के अर्ध-चक्र से कम के लिए
- (D) निवेश सिग्नल के केवल धनात्मक अर्ध-चक्र के लिए
- (iii) किसी पूर्ण-तरंग दिष्टकारी में : 1
- (A) किसी निश्चित समय पर दोनों डायोड अग्रदिशिक बायसित होते हैं।
- (B) किसी निश्चित समय पर दोनों डायोड पश्चदिशिक बायसित होते हैं।
- (C) किसी निश्चित समय पर एक अग्रदिशिक बायसित तथा दूसरा पश्चदिशिक बायसित होता है।
- (D) प्रथम अर्ध-चक्र में दोनों अग्रदिशिक बायसित होते हैं तथा द्वितीय अर्ध-चक्र में पश्चदिशिक बायसित होते हैं।
- (iv) (क) किसी अर्ध-तरंग दिष्टकारी पर 50 Hz आवृत्ति की कोई प्रत्यावर्ती वोल्टता अनुप्रयुक्त की गई है। तो निर्गत की उर्मिका आवृत्ति होगी : 1
- (A) 100 Hz (B) 50 Hz
- (C) 25 Hz (D) 150 Hz

अथवा

- (i) The root mean square value of an alternating voltage applied to a full-wave rectifier is $\frac{V_0}{\sqrt{2}}$. Then the root mean square value of the rectified output voltage is : 1
- (A) $\frac{V_0}{\sqrt{2}}$ (B) $\frac{V_0^2}{\sqrt{2}}$
 (C) $\frac{2V_0}{\sqrt{2}}$ (D) $\frac{V_0}{2\sqrt{2}}$
- (ii) In a full-wave rectifier, the current in each of the diodes flows for : 1
- (A) Complete cycle of the input signal
 (B) Half cycle of the input signal
 (C) Less than half cycle of the input signal
 (D) Only for the positive half cycle of the input signal
- (iii) In a full-wave rectifier : 1
- (A) Both diodes are forward biased at the same time.
 (B) Both diodes are reverse biased at the same time.
 (C) One is forward biased and the other is reverse biased at the same time.
 (D) Both are forward biased in the first half of the cycle and reverse biased in the second half of the cycle.
- (iv) (a) An alternating voltage of frequency of 50 Hz is applied to a half-wave rectifier. Then the ripple frequency of the output will be : 1
- (A) 100 Hz (B) 50 Hz
 (C) 25 Hz (D) 150 Hz

OR

(ख) आरेख में दर्शाए अनुसार कोई सिग्नल किसी p-n संधि डायोड पर अनुप्रयुक्त किया गया है। प्रतिरोध R_L के सिरो पर निर्गत की पहचान कीजिए :

1

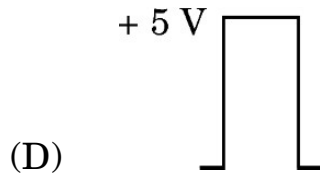
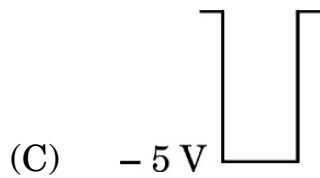
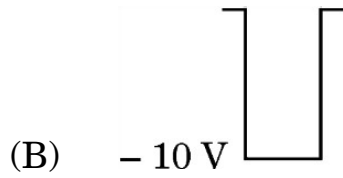
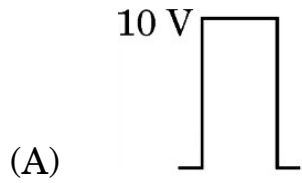
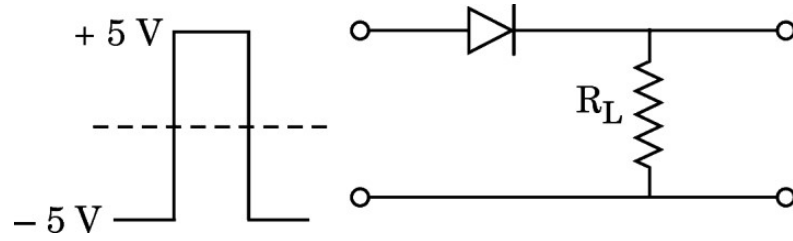

30. कोई लेंस दो पृष्ठों से घिरा कोई पारदर्शी माध्यम होता है जिसका एक अथवा दोनों पृष्ठ गोलीय होते हैं। किसी लेंस की फोकस दूरी उसके दोनों पृष्ठों की वक्रता त्रिज्याओं और लेंस के पदार्थ के, उस पदार्थ के सापेक्ष जिससे लेंस घिरा है, अपवर्तनांक द्वारा निर्धारित की जाती है। किसी लेंस की क्षमता उसकी फोकस दूरी की व्युत्क्रम होती है। यदि कई लेंसों को सम्पर्क में रखा जाता है, तो संयोजन की क्षमता उन लेंसों की अपनी-अपनी क्षमताओं का बीजगणितीय योग होता है।

- (b) A signal, as shown in the figure, is applied to a p-n junction diode. Identify the output across resistance R_L :

1

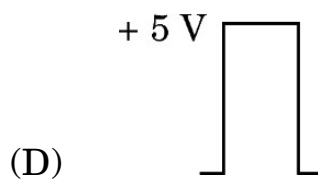
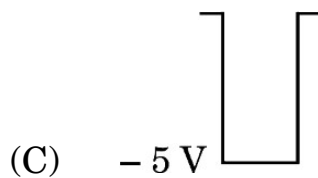
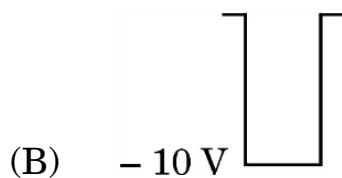
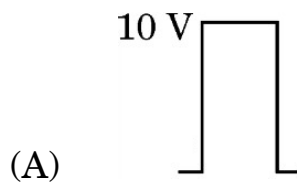
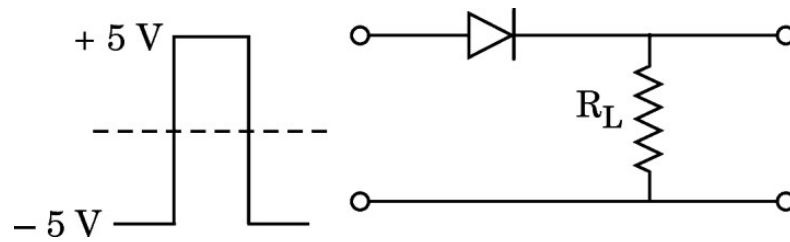

30. A lens is a transparent medium bounded by two surfaces, with one or both surfaces being spherical. The focal length of a lens is determined by the radii of curvature of its two surfaces and the refractive index of its medium with respect to that of the surrounding medium. The power of a lens is reciprocal of its focal length. If a number of lenses are kept in contact, the power of the combination is the algebraic sum of the powers of the individual lenses.

(i) किसी काँच के बने उभयोत्तल लेंस के दोनों फलकों की वक्रता त्रिज्या R समान है तथा काँच का अपवर्तनांक n है। इस लेंस की क्षमता है : 1

(A) $\frac{2(n-1)}{R}$ (B) $\frac{(2n-1)}{R}$

(C) $\frac{(n-1)}{2R}$ (D) $\frac{(2n-1)}{2R}$

(ii) क्षमता P के किसी उभयोत्तल लेंस, जिसके दोनों फलकों की वक्रता त्रिज्या समान है, को उसके मुख्य अक्ष के लम्बवत् दो समान भागों में काटा गया है। लेंस के एक भाग की क्षमता होगी : 1

(A) $2P$ (B) P (C) $4P$ (D) $\frac{P}{2}$

(iii) उपर्युक्त लेंस के दोनों भागों को आरेख में दर्शाए अनुसार एक-दूसरे के सम्पर्क में रखा गया है। इस संयोजन की क्षमता होगी : 1

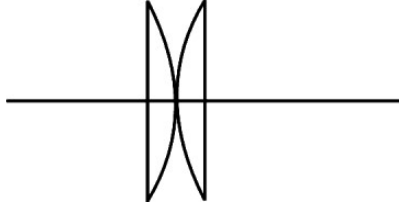

(A) $\frac{P}{2}$ (B) P (C) $2P$ (D) $\frac{P}{4}$

(iv) (क) क्षमता P के किसी उभयोत्तल लेंस, जिसके दोनों फलकों की वक्रता त्रिज्या समान है, को उसके मुख्य अक्ष के अनुदिश दो भागों में काटकर दोनों भागों को आरेख में दर्शाए अनुसार व्यवस्थित किया गया है। इस संयोजन की क्षमता होगी : 1

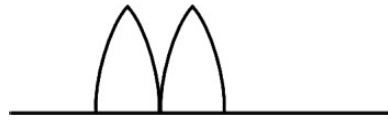

(A) शून्य (B) P
(C) $2P$ (D) $\frac{P}{2}$

अथवा

(ख) 60 cm और 20 cm फोकस दूरी के दो उत्तल लेंसों को एक-दूसरे के सम्पर्क में समाक्षतः रखा गया है। इस संयोजन की क्षमता है : 1

(A) 6.6 D (B) 15 D
(C) $\frac{1}{15}$ D (D) $\frac{1}{80}$ D

(i) A double-convex lens, with each face having same radius of curvature R , is made of glass of refractive index n . Its power is : 1

(A) $\frac{2(n-1)}{R}$ (B) $\frac{(2n-1)}{R}$

(C) $\frac{(n-1)}{2R}$ (D) $\frac{(2n-1)}{2R}$

(ii) A double-convex lens of power P , with each face having same radius of curvature, is cut into two equal parts perpendicular to its principal axis. The power of one part of the lens will be : 1

(A) $2P$ (B) P (C) $4P$ (D) $\frac{P}{2}$

(iii) The above two parts are kept in contact with each other as shown in the figure. The power of the combination will be : 1

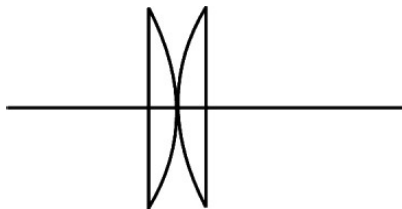

(A) $\frac{P}{2}$ (B) P (C) $2P$ (D) $\frac{P}{4}$

(iv) (a) A double-convex lens of power P , with each face having same radius of curvature, is cut along its principal axis. The two parts are arranged as shown in the figure. The power of the combination will be : 1

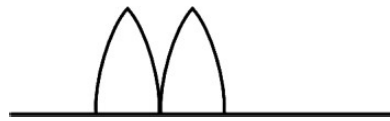

(A) Zero (B) P
(C) $2P$ (D) $\frac{P}{2}$

OR

(b) Two convex lenses of focal lengths 60 cm and 20 cm are held coaxially in contact with each other. The power of the combination is : 1

(A) 6.6 D (B) 15 D
(C) $\frac{1}{15}$ D (D) $\frac{1}{80}$ D

खण्ड ड

31. (क) (i) कोई प्रकाश किरण किसी त्रिभुजाकार प्रिज़्म से गुज़रती है। आपतन कोण के साथ विचलन कोण किस प्रकार विचरण करता है ? ग्राफ द्वारा दर्शाइए। अतः न्यूनतम विचलन कोण परिभाषित कीजिए।
- (ii) कोई प्रकाश किरण प्रिज़्म कोण A के किसी प्रिज़्म के एक अपवर्तक फलक पर अभिलम्बवत् आपतन करके कोण δ पर विचलित होती है। सिद्ध कीजिए कि प्रिज़्म के पदार्थ का अपवर्तनांक $n = \frac{\sin(A + \delta)}{\sin A}$ है।
- (iii) किसी प्रिज़्म के पदार्थ का अपवर्तनांक $\sqrt{2}$ है। यदि प्रिज़्म का अपवर्तक कोण 60° है, तो ज्ञात कीजिए :
- (1) न्यूनतम विचलन कोण, तथा
 - (2) आपतन कोण।

5

अथवा

- (ख) (i) हाइगेन्स का सिद्धान्त लिखिए। कोई समतल तरंग किसी परावर्ती पृष्ठ पर कोण i पर आपतन करती है। तदनुसूची परावर्तित तरंगाग्र की रचना कीजिए। इस आरेख का उपयोग करके, सिद्ध कीजिए कि परावर्तन कोण आपतन कोण के बराबर होता है।
- (ii) प्रकाश के कला-संबद्ध स्रोत क्या होते हैं ? क्या दो स्वतंत्र सोडियम लैम्प कला-संबद्ध स्रोत के रूप में कार्य कर सकते हैं ? व्याख्या कीजिए।
- (iii) यंग के द्विझिरी प्रयोग में किसी प्रकाश पुंज द्वारा, जिसमें दो तरंगदैर्घ्य, एक ज्ञात तरंगदैर्घ्य 520 nm की तथा दूसरी अज्ञात तरंगदैर्घ्य λ की है, दो ऐसे व्यतिकरण पैटर्न उत्पन्न करते हैं, जिनमें अज्ञात तरंगदैर्घ्य की चतुर्थ दीप्त फ्रिंज ज्ञात तरंगदैर्घ्य की पंचम दीप्त फ्रिंज के संपाती है। λ का मान ज्ञात कीजिए।

5



SECTION E

31. (a) (i) A ray of light passes through a triangular prism. Show graphically, how the angle of deviation varies with the angle of incidence ? Hence define the angle of minimum deviation.
- (ii) A ray of light is incident normally on a refracting face of a prism of prism angle A and suffers a deviation of angle δ . Prove that the refractive index n of the material of the prism is given by $n = \frac{\sin (A + \delta)}{\sin A}$.
- (iii) The refractive index of the material of a prism is $\sqrt{2}$. If the refracting angle of the prism is 60° , find the
- (1) Angle of minimum deviation, and
 - (2) Angle of incidence.

5

OR

- (b) (i) State Huygens' principle. A plane wave is incident at an angle i on a reflecting surface. Construct the corresponding reflected wavefront. Using this diagram, prove that the angle of reflection is equal to the angle of incidence.
- (ii) What are the coherent sources of light ? Can two independent sodium lamps act like coherent sources ? Explain.
- (iii) A beam of light consisting of a known wavelength 520 nm and an unknown wavelength λ , used in Young's double slit experiment produces two interference patterns such that the fourth bright fringe of unknown wavelength coincides with the fifth bright fringe of known wavelength. Find the value of λ .

5



32. (क) (i) किसी बाह्य एकसमान विद्युत-क्षेत्र \vec{E} में किसी विद्युत द्विध्रुव \vec{p} की स्थितिज ऊर्जा के लिए कोई व्यंजक व्युत्पन्न कीजिए। इस द्विध्रुव की स्थितिज ऊर्जा कब (1) अधिकतम, और (2) निम्नतम होती है ?
- (ii) कोई विद्युत द्विध्रुव बिन्दु आवेश -1.0 pC और $+1.0 \text{ pC}$ जो $x-y$ तल में क्रमशः $(0, 0)$ और $(3 \text{ mm}, 4 \text{ mm})$ पर स्थित हैं, से मिलकर बना है। इस प्रदेश में किसी विद्युत-क्षेत्र $\vec{E} = \left(\frac{1000 \text{ V}}{m}\right) \hat{i}$ को लगाया गया है। द्विध्रुव पर कार्यरत बल-आघूर्ण $\vec{\tau}$ ज्ञात कीजिए।

5

अथवा

- (ख) (i) $2a$ दूरी के पृथक्कन और $-q$ और q आवेशों से बना, कोई विद्युत द्विध्रुव (द्विध्रुव आघूर्ण $\vec{p} = p \hat{i}$) x -अक्ष के अनुदिश अपने केन्द्र को मूल-बिन्दु पर रखते हुए स्थित है। यह दर्शाइए कि इस द्विध्रुव के कारण किसी बिन्दु x , ($x \gg a$) पर विभव V , $\frac{1}{4\pi\epsilon_0} \cdot \frac{\vec{p} \cdot \hat{i}}{x^2}$ है।
- (ii) क्रमशः त्रिज्या 1 cm और 3 cm के दो वियुक्त धात्विक गोलों S_1 तथा S_2 को इस प्रकार आवेशित किया गया है कि उनके आवेश घनत्व समान $\left(\frac{2}{\pi} \times 10^{-9}\right) \text{ C/m}^2$ हैं। इन दोनों गोलों को एक-दूसरे से अत्यधिक दूरी पर रखकर किसी पतले तार से संयोजित किया गया है। गोले S_1 पर नया आवेश परिकलित कीजिए।

5

33. (क) (i) किसी ac स्रोत $v = v_m \sin \omega t$ से किसी प्रतिरोधक और किसी संधारित्र को श्रेणी में संयोजित किया गया है। परिपथ की प्रतिबाधा के लिए व्यंजक व्युत्पन्न कीजिए।
- (ii) कोई प्रेरक किसी परिपथ में चालक के रूप में कब कार्य करता है ? इसके लिए कारण दीजिए।



32. (a) (i) Derive an expression for potential energy of an electric dipole \vec{p} in an external uniform electric field \vec{E} . When is the potential energy of the dipole (1) maximum, and (2) minimum ?
- (ii) An electric dipole consists of point charges -1.0 pC and $+1.0 \text{ pC}$ located at $(0, 0)$ and $(3 \text{ mm}, 4 \text{ mm})$ respectively in $x - y$ plane. An electric field $\vec{E} = \left(\frac{1000 \text{ V}}{\text{m}}\right) \hat{i}$ is switched on in the region. Find the torque $\vec{\tau}$ acting on the dipole. 5

OR

- (b) (i) An electric dipole (dipole moment $\vec{p} = p \hat{i}$), consisting of charges $-q$ and q separated by distance $2a$, is placed along the x -axis, with its centre at the origin. Show that the potential V , due to this dipole, at a point x , ($x \gg a$) is equal to $\frac{1}{4\pi\epsilon_0} \cdot \frac{\vec{p} \cdot \hat{i}}{x^2}$.
- (ii) Two isolated metallic spheres S_1 and S_2 of radii 1 cm and 3 cm respectively are charged such that both have the same charge density $\left(\frac{2}{\pi} \times 10^{-9}\right) \text{ C/m}^2$. They are placed far away from each other and connected by a thin wire. Calculate the new charge on sphere S_1 . 5

33. (a) (i) A resistor and a capacitor are connected in series to an ac source $v = v_m \sin \omega t$. Derive an expression for the impedance of the circuit.
- (ii) When does an inductor act as a conductor in a circuit ? Give reason for it.

- (iii) किसी विद्युत लैम्प की अभिकल्पना 110 V dc और 11 A विद्युत धारा पर प्रचालन के लिए की गई है। यदि इस लैम्प को 220 V, 50 Hz के ac स्रोत पर श्रेणी में किसी कुण्डली के साथ प्रचालित किया जाता है, तो कुण्डली का प्रेरकत्व ज्ञात कीजिए।

5

अथवा

- (ख) (i) किसी उच्चायी ट्रान्सफॉर्मर का नामांकित आरेख खींचकर उसके कार्यकारी सिद्धान्त का वर्णन कीजिए। किसी वास्तविक ट्रान्सफॉर्मर में होने वाले ऊर्जा ह्रास के किन्हीं तीन कारणों की व्याख्या कीजिए।
- (ii) कोई उच्चायी ट्रान्सफॉर्मर किसी निम्न वोल्टता को उच्च वोल्टता में परिवर्तित करता है। क्या यह ऊर्जा संरक्षण नियम का उल्लंघन करता है? व्याख्या कीजिए।
- (iii) किसी उच्चायी ट्रान्सफॉर्मर की प्राथमिक और द्वितीयक कुण्डलियों में फेरों की संख्या क्रमशः 200 और 3000 है। प्राथमिक कुण्डली को दी गई निवेश वोल्टता 90 V है। परिकल्पित कीजिए :
- (1) द्वितीयक कुण्डली के सिरों पर निर्गत वोल्टता
 - (2) यदि द्वितीयक कुण्डली में धारा 2.0 A है, तो प्राथमिक कुण्डली में धारा

5



- (iii) An electric lamp is designed to operate at 110 V dc and 11 A current. If the lamp is operated on 220 V, 50 Hz ac source with a coil in series, then find the inductance of the coil.

5

OR

- (b) (i) Draw a labelled diagram of a step-up transformer and describe its working principle. Explain any three causes for energy losses in a real transformer.
- (ii) A step-up transformer converts a low voltage into high voltage. Does it violate the principle of conservation of energy? Explain.
- (iii) A step-up transformer has 200 and 3000 turns in its primary and secondary coils respectively. The input voltage given to the primary coil is 90 V. Calculate :
- (1) The output voltage across the secondary coil
 - (2) The current in the primary coil if the current in the secondary coil is 2.0 A.

5



Marking Scheme
Strictly Confidential
(For Internal and Restricted use only)
Senior School Certificate Examination, 2024
SUBJECT NAME PHYSICS (Theory) (CODE 55/1/1)

General Instructions: -

1	You are aware that evaluation is the most important process in the actual and correct assessment of the candidates. A small mistake in evaluation may lead to serious problems which may affect the future of the candidates, education system and teaching profession. To avoid mistakes, it is requested that before starting evaluation, you must read and understand the spot evaluation guidelines carefully.
2	“Evaluation policy is a confidential policy as it is related to the confidentiality of the examinations conducted, Evaluation done and several other aspects. Its’ leakage to public in any manner could lead to derailment of the examination system and affect the life and future of millions of candidates. Sharing this policy/document to anyone, publishing in any magazine and printing in News Paper/Website etc may invite action under various rules of the Board and IPC.”
3	Evaluation is to be done as per instructions provided in the Marking Scheme. It should not be done according to one’s own interpretation or any other consideration. Marking Scheme should be strictly adhered to and religiously followed. However, while evaluating, answers which are based on latest information or knowledge and/or are innovative, they may be assessed for their correctness otherwise and due marks be awarded to them. In class-X, while evaluating two competency-based questions, please try to understand given answer and even if reply is not from marking scheme but correct competency is enumerated by the candidate, due marks should be awarded.
4	The Marking scheme carries only suggested value points for the answers These are in the nature of Guidelines only and do not constitute the complete answer. The students can have their own expression and if the expression is correct, the due marks should be awarded accordingly.
5	The Head-Examiner must go through the first five answer books evaluated by each evaluator on the first day, to ensure that evaluation has been carried out as per the instructions given in the Marking Scheme. If there is any variation, the same should be zero after deliberation and discussion. The remaining answer books meant for evaluation shall be given only after ensuring that there is no significant variation in the marking of individual evaluators.
6	Evaluators will mark(√) wherever answer is correct. For wrong answer CROSS ‘X’ be marked. Evaluators will not put right (✓) while evaluating which gives an impression that answer is correct and no marks are awarded. This is most common mistake which evaluators are committing.
7	If a question has parts, please award marks on the right-hand side for each part. Marks awarded for different parts of the question should then be totaled up and written in the left-hand margin and encircled. This may be followed strictly.



8	If a question does not have any parts, marks must be awarded in the left-hand margin and encircled. This may also be followed strictly.
9	If a student has attempted an extra question, answer of the question deserving more marks should be retained and the other answer scored out with a note “ Extra Question ”.
10	No marks to be deducted for the cumulative effect of an error. It should be penalized only once.
11	A full scale of marks 0 to 70 has to be used. Please do not hesitate to award full marks if the answer deserves it.
12	Every examiner has to necessarily do evaluation work for full working hours i.e., 8 hours every day and evaluate 20 answer books per day in main subjects and 25 answer books per day in other subjects (Details are given in Spot Guidelines). This is in view of the reduced syllabus and number of questions in question paper.
13	<p>Ensure that you do not make the following common types of errors committed by the Examiner in the past:-</p> <ul style="list-style-type: none"> ● Leaving answer or part thereof unassessed in an answer book. ● Giving more marks for an answer than assigned to it. ● Wrong totaling of marks awarded on an answer. ● Wrong transfer of marks from the inside pages of the answer book to the title page. ● Wrong question wise totaling on the title page. ● Wrong totaling of marks of the two columns on the title page. ● Wrong grand total. ● Marks in words and figures not tallying/not same. ● Wrong transfer of marks from the answer book to online award list. ● Answers marked as correct, but marks not awarded. (Ensure that the right tick mark is correctly and clearly indicated. It should merely be a line. Same is with the X for incorrect answer.) ● Half or a part of answer marked correct and the rest as wrong, but no marks awarded.
14	While evaluating the answer books if the answer is found to be totally incorrect, it should be marked as cross (X) and awarded zero (0) Marks.
15	Any un assessed portion, non-carrying over of marks to the title page, or totaling error detected by the candidate shall damage the prestige of all the personnel engaged in the evaluation work as also of the Board. Hence, in order to uphold the prestige of all concerned, it is again reiterated that the instructions be followed meticulously and judiciously.
16	The Examiners should acquaint themselves with the guidelines given in the “ Guidelines for spot Evaluation ” before starting the actual evaluation.
17	Every Examiner shall also ensure that all the answers are evaluated, marks carried over to the title page, correctly totaled and written in figures and words.
18	The candidates are entitled to obtain photocopy of the Answer Book on request on payment of the prescribed processing fee. All Examiners/Additional Head Examiners/Head Examiners are once again reminded that they must ensure that evaluation is carried out strictly as per value points for each answer as given in the Marking Scheme.



	$(ii) m = -\frac{v}{u}$ $= -\left(\frac{-60}{-30}\right)$ $= -2$	$\frac{1}{2}$ $\frac{1}{2}$	2
20.	<div style="border: 1px solid black; padding: 5px; margin-bottom: 10px;"> Obtaining an expression for λ_n / λ_p 2 </div> $E = \frac{hc}{\lambda_p} \Rightarrow \lambda_p = \frac{hc}{E}$ $\lambda_n = \frac{h}{p} = \frac{h}{\sqrt{2mE}}$ $\frac{\lambda_n}{\lambda_p} = \frac{h}{\sqrt{2mE}} \times \frac{E}{hc}$ $\frac{\lambda_n}{\lambda_p} = \sqrt{\left(\frac{E}{2mc^2}\right)}$	$\frac{1}{2}$ $\frac{1}{2}$ $\frac{1}{2}$ $\frac{1}{2}$	2
21.	<div style="border: 1px solid black; padding: 5px; margin-bottom: 10px;"> Plotting the graph 1 Marking the region where: (a) resistance is negative $\frac{1}{2}$ (b) Ohm's law is obeyed $\frac{1}{2}$ </div>	$1 + \frac{1}{2} + \frac{1}{2}$	2

SECTION C

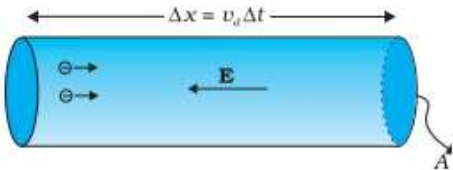
22.	<div style="border: 1px solid black; padding: 5px; margin-bottom: 10px;"> <p>Calculating</p> <p>(a) the flux passing through the cube 2</p> <p>(b) the charge within the cube 1</p> </div> <p>a) $\Phi_L = \vec{E}_L \cdot \vec{A} = - [500 \times 0.1] \times [(0.1)^2] = - 0.5 \text{ N m}^2 \text{ C}^{-1}$</p> <p>$\Phi_R = \vec{E}_R \cdot \vec{A} = [500 \times 0.2] \times [(0.1)^2] = 1 \text{ N m}^2 \text{ C}^{-1}$</p> <p>Net flux = $\Phi_L + \Phi_R = 0.5 \text{ N m}^2 \text{ C}^{-1}$</p> <p>b) flux, $\phi = \frac{q}{\epsilon_0}$</p> <p>charge, $q = \phi \times \epsilon_0$ $= 0.5 \epsilon_0$ $= 4.4 \times 10^{-12} \text{ C}$</p>	<p>$\frac{1}{2}$</p> <p>$\frac{1}{2}$</p> <p>1</p> <p>$\frac{1}{2}$</p> <p>$\frac{1}{2}$</p>	3
23.	<p>a)</p> <div style="border: 1px solid black; padding: 5px; margin-bottom: 10px;"> <ul style="list-style-type: none"> • Defining current density $\frac{1}{2}$ • Whether scalar or vector $\frac{1}{2}$ • Showing $\vec{j} = \alpha \vec{E}$ 2 </div> <p>Current density is the amount of charge flowing per second per unit area normal to the flow.</p> <p>Alternatively:</p> $j = \frac{I}{A}$ <p>It is a vector quantity.</p> <div style="text-align: center; margin: 10px 0;">  </div> <p>The amount of charge crossing the area A in time Δt is $I \Delta t$, where I is the magnitude of the current. Hence,</p> $I \Delta t = ne A v_d \Delta t$	<p>$\frac{1}{2}$</p> <p>$\frac{1}{2}$</p> <p>$\frac{1}{2}$</p>	

$$I \Delta t = \frac{e^2 A}{m} \tau n \Delta t |E|$$

$$I = |j|A$$

$$|j| = \frac{ne^2}{m} \tau |E|$$

$$\vec{j} = \alpha \vec{E}$$

OR

b)

Defining Wheatstone bridge	1
Obtaining balancing conditions	2

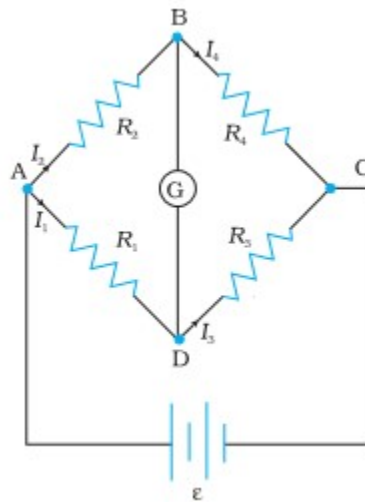

Alternatively:

If the figure is explained in words full credit to be given.

For loop ADBA:

$$-I_1 R_1 + I_2 R_2 + I_g G = 0 \quad (1)$$

For loop CBDC:

$$I_4 R_4 - I_3 R_3 - I_g G = 0 \quad (2)$$

For balanced wheatstone bridge, $I_g = 0$

And by applying Kirchoff's junction rule to junction D and B,

$$I_1 = I_3 \text{ \& } I_2 = I_4$$

From eqn (1) and (2)

½

½

½

1

½

½

½

	$\frac{I_1}{I_2} = \frac{R_2}{R_1} \text{ and } \frac{I_1}{I_2} = \frac{R_4}{R_3}$ $\Rightarrow \frac{R_2}{R_1} = \frac{R_4}{R_3}$	1/2	3
24.	<div style="border: 1px solid black; padding: 5px;"> <p>Calculating</p> <p>a) the speed of the proton 1</p> <p>b) the magnitude of the acceleration of the proton 1</p> <p>c) the radius of the path traced by the proton 1</p> </div> <p>a) $v = \sqrt{\left(\frac{2 \times \text{K.E.}}{m}\right)}$</p> <p style="margin-left: 40px;">$= 4 \times 10^6 \text{ m/s}$</p> <p>b) acceleration = qvB / m</p> <p style="margin-left: 40px;">$= 8 \times 10^{11} \text{ m/s}^2$</p> <p>c) $r = mv / Bq$</p> <p style="margin-left: 40px;">$= 20 \text{ m}$</p>	1/2 1/2 1/2 1/2	3
25.	<div style="border: 1px solid black; padding: 5px;"> <p>Deriving an expression for the average power dissipated in series LCR circuit 2</p> <p>Obtaining expression for the resonant frequency 1</p> </div> <p>$v = v_m \sin \omega t$</p> <p>$i = i_m \sin(\omega t + \phi)$</p> <p>Power, $P = v i = (v_m \sin \omega t) \times [i_m \sin(\omega t + \phi)]$</p> $= \frac{v_m i_m}{2} [\cos \phi - \cos(2\omega t + \phi)] \quad (1)$ <p>The average power over a cycle is given by the average of the two terms in RHS of eqn (1). It is only the 2nd term which is time dependent. It's average is zero. Therefore,</p> $P = \frac{v_m i_m}{2} \cos \phi$	1/2 1/2 1/2	

	<p> $P = V I \cos \phi$ OR $P = I^2 Z \cos \phi$ </p> <p>At resonance, $X_C = X_L$</p> $\frac{1}{\omega C} = \omega L$ $\omega = \frac{1}{\sqrt{LC}}$ $\Rightarrow \nu = \frac{1}{2\pi\sqrt{LC}}$	<p>$\frac{1}{2}$</p> <p>$\frac{1}{2}$</p> <p>$\frac{1}{2}$</p>	<p>3</p>
26.	<div style="border: 1px solid black; padding: 5px; margin-bottom: 10px;"> <p>a) Two examples 1</p> <p>b) (i) Reason for use of short waves bands 1</p> <p style="padding-left: 20px;">(ii) Reason for x-ray astronomy from satellites 1</p> </div> <p>a) (Any Two)</p> <ul style="list-style-type: none"> • Gamma radiation having wavelength of 10^{-14} m to 10^{-15} m, typically originate from an atomic nucleus. • X-rays are emitted from heavy atoms. • Radio waves are produced by accelerating electrons in a circuit. A transmitting antenna can most efficiently radiate waves having a wavelength of about the same size as the antenna. <p>b) (i) Ionosphere reflects waves in these bands (ii) Atmosphere absorbs x-rays, while visible and radio waves can penetrate it</p> <p>Note: Full credit to be given for part (b) for mere attempt.</p>	<p>$\frac{1}{2} + \frac{1}{2}$</p> <p>1</p> <p>1</p>	<p>3</p>
27.	<div style="border: 1px solid black; padding: 5px; margin-bottom: 10px;"> <ul style="list-style-type: none"> • Drawbacks of Rutherford's atomic model 1 • Bohr's explanation 1 • Showing different orbits are not equally spaced 1 </div> <p>Drawbacks:</p> <p>i) According to classical electromagnetic theory, an accelerating charged particle emits radiation in the form of electromagnetic waves. The energy of an accelerating electron should therefore, continuously decrease. The electron would spiral inward and eventually fall into the nucleus. Thus, such</p>		

	<p>an atom cannot be stable. ii) As the electrons spiral inwards, their angular velocities and hence their frequencies would change continuously. Thus, they would emit a continuous spectrum, in contradiction to the line spectrum actually observed.</p> <p>Bohr postulated stable orbits in which electrons do not radiate energy Alternatively: Bohr's postulates (Any ONE of the three) (i) An electron in an atom could revolve in certain stable orbits without the emission of radiant energy. (ii) The electron revolves around the nucleus only in those orbits for which the angular momentum is some integral multiple of $h/2\pi$ (iii) An electron might make a transition from one of its specified non-radiating orbits to another of lower energy. When it does so, a photon is emitted having energy equal to the energy difference between the initial and final states.</p> <p>The radius of the n^{th} orbit is found as</p> $r_n = \left(\frac{n^2}{m}\right) \left(\frac{h}{2\pi}\right)^2 \frac{4\pi\epsilon_0}{e^2}$ $r_n \propto n^2$ <p>Alternatively: Difference in radius of consecutive orbits is $r_{n+1} - r_n = k [(n+1)^2 - n^2]$ $= k (2n + 1)$ which depends on n, and is not a constant</p>	<p>1</p> <p>1</p> <p>1</p>	<p>3</p>						
<p>28.</p>	<table border="1" style="width: 100%; border-collapse: collapse;"> <tr> <td style="padding: 5px;">a) Stating two properties of a nucleus</td> <td style="text-align: right; padding: 5px;">1</td> </tr> <tr> <td style="padding: 5px;">b) Why density of a nucleus is much more than that of an atom</td> <td style="text-align: right; padding: 5px;">1</td> </tr> <tr> <td style="padding: 5px;">c) Showing that density of nuclear matter is same for all nuclei</td> <td style="text-align: right; padding: 5px;">1</td> </tr> </table> <p>a) (Any TWO) (i) The nucleus is positively charged (ii) The nucleus consists of protons and neutrons (iii) The nuclear density is independent of mass number (iv) The radius of the nucleus, $R = R_0 A^{1/3}$</p> <p>b) Atoms have large amount of empty spaces. Mass is concentrated in nucleus.</p>	a) Stating two properties of a nucleus	1	b) Why density of a nucleus is much more than that of an atom	1	c) Showing that density of nuclear matter is same for all nuclei	1	<p>$\frac{1}{2} + \frac{1}{2}$</p> <p>1</p>	
a) Stating two properties of a nucleus	1								
b) Why density of a nucleus is much more than that of an atom	1								
c) Showing that density of nuclear matter is same for all nuclei	1								

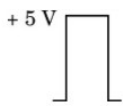
	<p>c) Density = Mass / Volume</p> $= \frac{m A}{\frac{4}{3}\pi R^3} = \frac{m A}{\frac{4}{3}\pi R_0^3 A}$ $= \frac{m}{\frac{4}{3}\pi R_0^3}$ <p>So, density is independent of mass number</p>	1	3
	<u>SECTION D</u>		
29.	<p>(i) (A) $\frac{2(n-1)}{R}$</p> <p>(ii) (D) P/2</p> <p>(iii) (B) P</p> <p>(iv) a) (C) 2P OR b) (A) 6.6 D</p>	1 1 1 1	4
30.	<p>(i) (A) $\frac{V_o}{\sqrt{2}}$</p> <p>(ii) (B) half cycle of the input signal</p> <p>(iii) (C) One is forward biased and the other is reverse biased at the same time</p> <p>(iv) a) (B) 50 Hz OR b) (D) </p>	1 1 1 1	4



Section E

31.

(a)

(i)

- Deriving the expression for potential energy 2
 - Maximum & Minimum value of potential energy ($\frac{1}{2} + \frac{1}{2}$)
- (ii) Finding the torque. 2

(i)

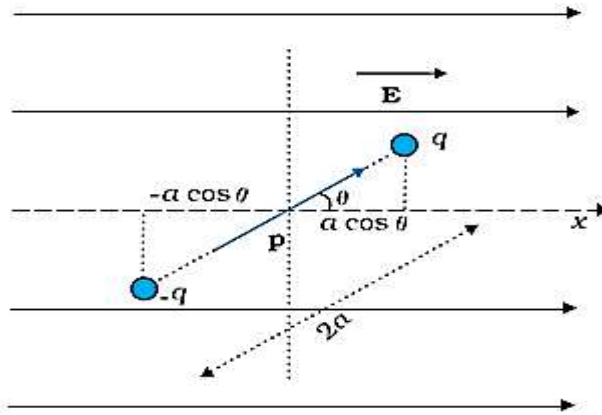

The amount of work done in rotating the dipole from $\theta = \theta_0$ to $\theta = \theta_1$ by the external torque

$$W = \int_{\theta_0}^{\theta_1} \tau_{ext} d\theta$$

$$= \int_{\theta_0}^{\theta_1} pE \sin \theta d\theta$$

$$W = pE(\cos \theta_0 - \cos \theta_1)$$

For $\theta_0 = \frac{\pi}{2}$ and $\theta_1 = \theta$

$$= pE(\cos \frac{\pi}{2} - \cos \theta)$$

$$U(\theta) = -pE \cos \theta$$

$$= -\vec{p} \cdot \vec{E}$$

$\frac{1}{2}$

$\frac{1}{2}$

$\frac{1}{2}$

$\frac{1}{2}$

(1) Potential energy is maximum when:

\vec{p} is antiparallel to \vec{E}

Alternatively:

$$\theta = 180^\circ \text{ or } \pi \text{ radians}$$

$\frac{1}{2}$

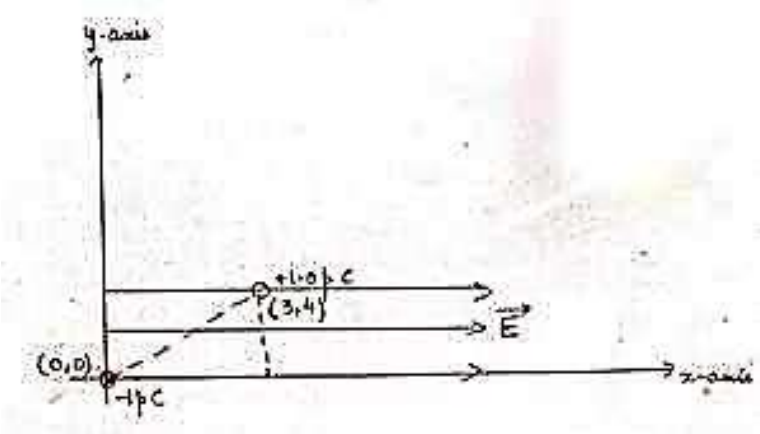
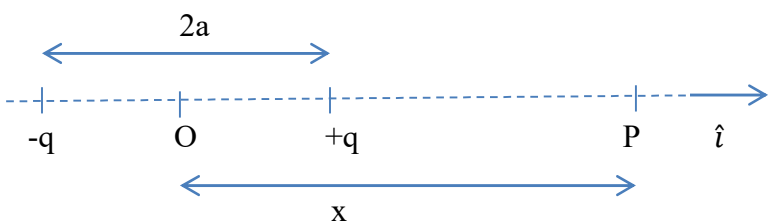
	<p>(2) Potential energy is minimum when: \vec{p} is along to \vec{E} Alternatively: $\theta = 0^\circ$</p> <p>(ii)</p>  <p> $\tau = pE \sin \theta$ $= (2aq)E \sin \theta$ $= (5 \times 10^{-3} \times 1 \times 10^{-12}) 10^3 \times \frac{4}{5}$ $= 4 \times 10^{-12} \text{ Nm}$ Direction is along -ve Z direction. </p>	<p>$\frac{1}{2}$</p> <p>$\frac{1}{2}$</p> <p>$\frac{1}{2}$</p> <p>$\frac{1}{2}$</p>					
	<p style="text-align: center;">OR</p> <p>(b)</p> <table border="1" data-bbox="289 1213 1010 1318"> <tbody> <tr> <td>(i) Deriving expression for potential</td> <td>2 $\frac{1}{2}$</td> </tr> <tr> <td>(ii) New charge on Sphere S_1</td> <td>2 $\frac{1}{2}$</td> </tr> </tbody> </table> <p>(i)</p>  <p> $V = \frac{1}{4\pi\epsilon_0} \frac{q}{r}$ $V = V_{+q} - V_{-q}$ </p>	(i) Deriving expression for potential	2 $\frac{1}{2}$	(ii) New charge on Sphere S_1	2 $\frac{1}{2}$	<p>$\frac{1}{2}$</p> <p>$\frac{1}{2}$</p>	
(i) Deriving expression for potential	2 $\frac{1}{2}$						
(ii) New charge on Sphere S_1	2 $\frac{1}{2}$						

$$V = \frac{1}{4\pi\epsilon_0} \left[\frac{q}{(x-a)} - \frac{q}{(x+a)} \right]$$

$$= \frac{q}{4\pi\epsilon_0} \left[\frac{x+a-x+a}{(x^2-a^2)} \right]$$

$$V = \frac{q}{4\pi\epsilon_0} \frac{2a}{(x^2-a^2)} = \frac{p}{4\pi\epsilon_0(x^2-a^2)}$$

As p is along x-axis, so

$$V = \frac{1}{4\pi\epsilon_0} \frac{\vec{p} \cdot \hat{i}}{(x^2-a^2)}$$

If $x \gg a$

$$V = \frac{1}{4\pi\epsilon_0} \frac{\vec{p} \cdot \hat{i}}{x^2}$$

Alternatively:

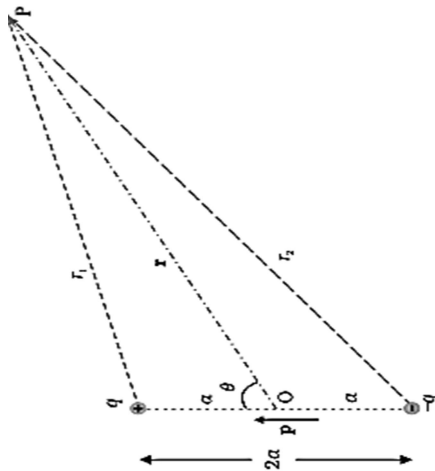

$$V = \frac{1}{4\pi\epsilon_0} \left(\frac{q}{r_1} - \frac{q}{r_2} \right)$$

----- (i)

1/2

1/2

1/2

1/2

By geometry

$$r_1^2 = r^2 + a^2 - 2ar \cos \theta$$

$$r_2^2 = r^2 + a^2 + 2ar \cos \theta$$

$$r_1^2 = r^2 \left(1 - \frac{2a \cos \theta}{r} + \frac{a^2}{r^2} \right)$$

$$\cong r^2 \left(1 - \frac{2a \cos \theta}{r} \right)$$

Similarly, $r_2^2 \cong r^2 \left(1 + \frac{2a \cos \theta}{r} \right)$

Using binomial theorem & retaining terms upto the first order in $\frac{a}{r}$; we obtain

$$\frac{1}{r_1} \cong \frac{1}{r} \left(1 - \frac{2a \cos \theta}{r} \right)^{-\frac{1}{2}} \cong \frac{1}{r} \left(1 + \frac{a}{r} \cos \theta \right) \quad \text{----- (ii)}$$

$$\frac{1}{r_2} \cong \frac{1}{r} \left(1 - \frac{2a \cos \theta}{r} \right)^{-\frac{1}{2}} \cong \frac{1}{r} \left(1 - \frac{a}{r} \cos \theta \right) \quad \text{----- (iii)}$$

Using equations (i), (ii) & (iii) & $p = 2qa$

$$V = \frac{q}{4\pi\epsilon_0} \frac{2a \cos \theta}{r^2} = \frac{p \cos \theta}{4\pi\epsilon_0 r^2}$$

$$p \cos \theta = \vec{p} \cdot \hat{r}$$

As \vec{r} is along the x - axis.

$$\Rightarrow \vec{p} \cdot \hat{r} = \vec{p} \cdot \hat{i}$$

$$\Rightarrow V = \frac{1}{4\pi\epsilon_0} \frac{\vec{p} \cdot \hat{i}}{x^2}$$

$\frac{1}{2}$

$\frac{1}{2}$

$\frac{1}{2}$

$\frac{1}{2}$

(ii)

Charge on sphere S_1 :

$$\begin{aligned} Q_1 &= \text{surface charge density} \times \text{surface Area} \\ &= \left(\frac{2}{\pi} \times 10^{-9} \right) \times 4\pi (1 \times 10^{-2})^2 \\ &= 8 \times 10^{-13} \text{ C} \end{aligned}$$

$\frac{1}{2}$

Charge on sphere S_2 :

$$\begin{aligned} Q_2 &= \text{surface charge density} \times \text{surface Area} \\ &= \left(\frac{2}{\pi} \times 10^{-9} \right) \times 4\pi (3 \times 10^{-2})^2 \\ &= 72 \times 10^{-13} \text{ C} \end{aligned}$$

$\frac{1}{2}$

When connected by a thin wire they acquire a common potential V and the charge remains conserved.

$$Q_1 + Q_2 = Q'_1 + Q'_2$$

$\frac{1}{2}$

$$= C_1 V + C_2 V$$

$$Q_1 + Q_2 = (C_1 + C_2) V$$

$$\text{Common potential}(V) = \frac{Q_1 + Q_2}{C_1 + C_2}$$

$$C_1 = 4\pi\epsilon_0 r_1 = \frac{1}{9 \times 10^9} \times 10^{-2} = \frac{1}{9} \times 10^{-11} \text{ F}$$

$$C_2 = 4\pi\epsilon_0 r_2 = \frac{1}{9 \times 10^9} \times 3 \times 10^{-2} = \frac{1}{3} \times 10^{-11} \text{ F}$$

$$V = \frac{80 \times 10^{-13}}{\left(\frac{1}{9} + \frac{1}{3} \right) \times 10^{-11}} = 1.8 \text{ V}$$

$\frac{1}{2}$

$$Q'_1 = C_1 V = \frac{1}{9} \times 10^{-11} \times 1.8$$

$$Q'_1 = 2 \times 10^{-12} \text{ C}$$

$\frac{1}{2}$

	<p>Alternatively:</p> <p>Charge on sphere S_1 :</p> $Q_1 = \text{surface charge density} \times \text{surface Area}$ $= \left(\frac{2}{\pi} \times 10^{-9}\right) \times 4\pi (1 \times 10^{-2})^2$ $= 8 \times 10^{-13} \text{ C}$ <p>Charge on sphere S_2 :</p> $Q_2 = \text{surface charge density} \times \text{surface Area}$ $= \left(\frac{2}{\pi} \times 10^{-9}\right) \times 4\pi (3 \times 10^{-2})^2$ $= 72 \times 10^{-13} \text{ C}$ <p>When connected by a thin wire they acquire a common potential V and the charge remains conserved.</p> $Q_1 + Q_2 = Q'_1 + Q'_2$ $\frac{Q'_2}{Q'_1} = \frac{r_2}{r_1}$ <p>On solving, $Q'_1 = 2 \times 10^{-12} \text{ C}$</p>	<p>$\frac{1}{2}$</p> <p>$\frac{1}{2}$</p> <p>$\frac{1}{2}$</p> <p>$\frac{1}{2}$</p>	<p>5</p>						
<p>32.</p>	<p>(a)</p> <table border="1" data-bbox="324 1444 1096 1585"> <tr> <td>(i) Deriving expression for impedance</td> <td>2</td> </tr> <tr> <td>(ii) Reason</td> <td>1</td> </tr> <tr> <td>(iii) Inductance of coil</td> <td>2</td> </tr> </table>	(i) Deriving expression for impedance	2	(ii) Reason	1	(iii) Inductance of coil	2		
(i) Deriving expression for impedance	2								
(ii) Reason	1								
(iii) Inductance of coil	2								

(i)

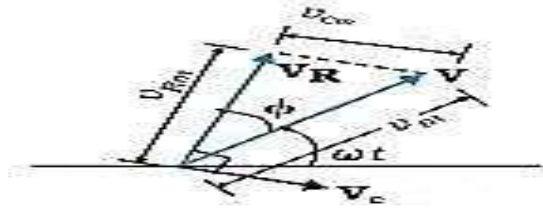

$$V_C + V_R = V$$

$$v_m^2 = v_{rm}^2 + v_{cm}^2$$

$$v_{rm} = i_m R$$

$$v_{cm} = i_m X_c$$

$$v_m^2 = (i_m R)^2 + (i_m X_c)^2$$

$$= i_m^2 [R^2 + X_c^2]$$

$$\Rightarrow i_m = \frac{v_m}{\sqrt{R^2 + X_c^2}}$$

$$\Rightarrow \text{Impedance } Z = \sqrt{R^2 + X_c^2}$$

(ii) For direct current (dc), an inductor behaves as a conductor.

$$\text{As } X_L = \omega L = 2\pi \nu L$$

$$\text{For dc } \nu = 0 \Rightarrow X_L = 0$$

Alternatively: -

$$\text{Induced emf } (\mathcal{E}) = - \frac{L dI}{dt}$$

$$\text{For dc; } dI = 0 \Rightarrow \mathcal{E} = 0$$

1/2

1/2

1/2

1/2

1

	<p>(iii) $R = \frac{110}{11} = 10 \Omega$</p> $i_{rms} = \frac{v_{rms}}{\sqrt{R^2 + X_L^2}} = \frac{220}{\sqrt{100 + X_L^2}}$ $11 = \frac{220}{\sqrt{100 + X_L^2}}$ $\sqrt{100 + X_L^2} = \frac{220}{11} = 20\Omega$ <p>Squaring both sides:</p> $\Rightarrow 100 + X_L^2 = 400$ $\Rightarrow X_L^2 = 300 \Rightarrow X_L = 10\sqrt{3} \Omega$ $X_L = 2\pi fL \Rightarrow 10\sqrt{3} = 2\pi \times 50 \times L$ $L = \frac{\sqrt{3}}{10\pi} H$ <p style="text-align: center;">OR</p>	<p style="text-align: center;">$\frac{1}{2}$</p> <p style="text-align: center;">$\frac{1}{2}$</p> <p style="text-align: center;">$\frac{1}{2}$</p> <p style="text-align: center;">$\frac{1}{2}$</p>													
	<p>(b)</p> <table border="1" style="width: 100%; border-collapse: collapse;"> <tbody> <tr> <td>(i) Labelled diagram of step – up transformer</td> <td style="text-align: right;">1</td> </tr> <tr> <td> Describing working principle</td> <td style="text-align: right;">$\frac{1}{2}$</td> </tr> <tr> <td> Three causes</td> <td style="text-align: right;">$1 \frac{1}{2}$</td> </tr> <tr> <td>(ii) Explanation</td> <td style="text-align: right;">1</td> </tr> <tr> <td>(iii) (1) Output voltage across secondary coil</td> <td style="text-align: right;">$\frac{1}{2}$</td> </tr> <tr> <td> (2) Current in primary coil</td> <td style="text-align: right;">$\frac{1}{2}$</td> </tr> </tbody> </table>	(i) Labelled diagram of step – up transformer	1	Describing working principle	$\frac{1}{2}$	Three causes	$1 \frac{1}{2}$	(ii) Explanation	1	(iii) (1) Output voltage across secondary coil	$\frac{1}{2}$	(2) Current in primary coil	$\frac{1}{2}$		
(i) Labelled diagram of step – up transformer	1														
Describing working principle	$\frac{1}{2}$														
Three causes	$1 \frac{1}{2}$														
(ii) Explanation	1														
(iii) (1) Output voltage across secondary coil	$\frac{1}{2}$														
(2) Current in primary coil	$\frac{1}{2}$														

(i)

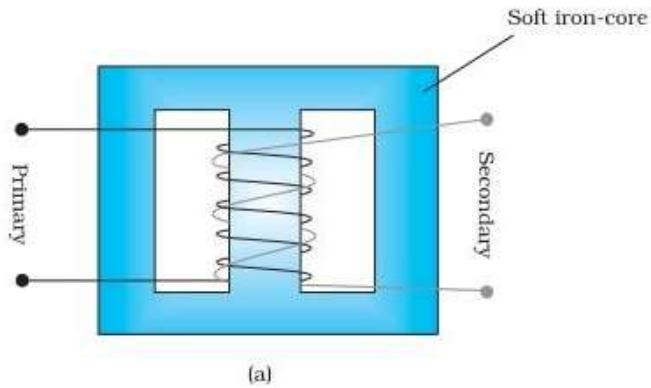

OR

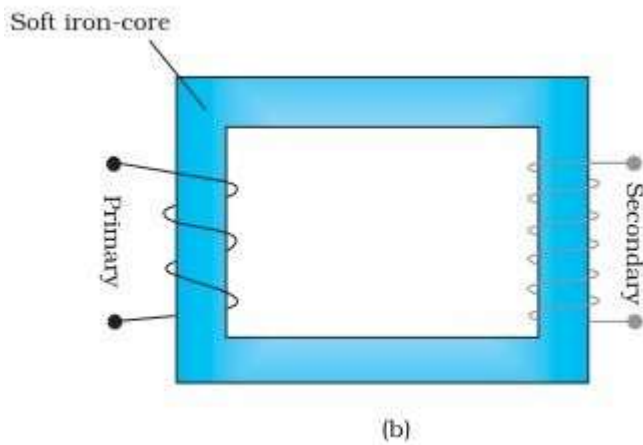

The working principle of transformer is mutual induction.

When an alternating voltage is applied to the primary, the resulting current produces an alternating magnetic flux which links the secondary and induces an emf in it.

Causes of energy losses (Any three)

(a) Flux leakage

(b) Resistance of the windings

(c) Eddy currents

1

$\frac{1}{2}$

(i)

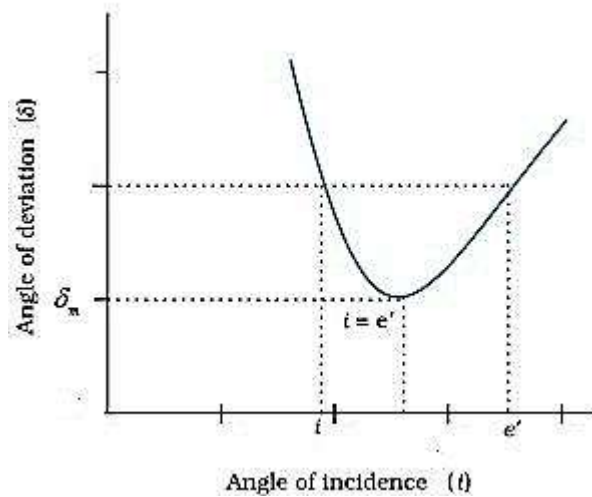

1

Minimum deviation angle is defined as the angle at which angle of incidence is equal to the angle of emergence.

1

Alternatively

At minimum deviation refracted ray inside the prism becomes parallel to the base of the prism.

(ii)

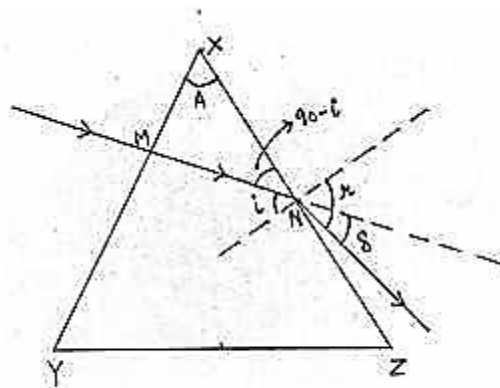

At the face XZ :-

$$\mu \sin i = 1 \times \sin r \quad \text{----- (1)}$$

$$r = i + \delta \quad \text{[from diagram]} \quad \text{----- (2)}$$

$$\text{In } \Delta XMN; A + (90 - i) + 90 = 180$$

$\frac{1}{2}$

	$\Rightarrow A = i \quad \text{----- (3)}$ <p>Putting eq. (3) & (2) in eq. (1)</p> $\mu \sin A = \sin (A + \delta)$ $\mu = \frac{\sin (A + \delta)}{\sin A}$ <p>(iii)</p> $(1) \quad \mu = \frac{\sin \left(\frac{A + \delta_m}{2} \right)}{\sin \frac{A}{2}}$ $\sqrt{2} = \frac{\sin \left(\frac{60 + \delta_m}{2} \right)}{\sin 30^\circ}$ $\Rightarrow \sin \left(\frac{60 + \delta_m}{2} \right) = \frac{1}{\sqrt{2}} = \sin 45^\circ$ $\frac{60 + \delta_m}{2} = 45^\circ \Rightarrow \delta_m = 30^\circ$ $(2) \quad i = \frac{A + \delta_m}{2}$ $\Rightarrow i = \frac{60 + 30}{2}$ $i = 45^\circ$ <p style="text-align: center;">OR</p>	<p>$\frac{1}{2}$</p> <p>$\frac{1}{2}$</p> <p>$\frac{1}{2}$</p> <p>$\frac{1}{2}$</p> <p>$\frac{1}{2}$</p>													
	<p>(b)</p> <table border="1" style="width: 100%; border-collapse: collapse;"> <tbody> <tr> <td>(i) Statement of Huygens' Principle</td> <td style="text-align: right;">$\frac{1}{2}$</td> </tr> <tr> <td>Construction of reflected wave front</td> <td style="text-align: right;">$\frac{1}{2}$</td> </tr> <tr> <td>Proof of angle of reflection is equal to angle of incidence</td> <td style="text-align: right;">1</td> </tr> <tr> <td>(ii) Definition of coherent sources</td> <td style="text-align: right;">$\frac{1}{2}$</td> </tr> <tr> <td>Explanation</td> <td style="text-align: right;">1</td> </tr> <tr> <td>(iii) Finding the unknown wavelength</td> <td style="text-align: right;">$1 \frac{1}{2}$</td> </tr> </tbody> </table> <p>(i) Each point of the wavefront is the source of a secondary disturbance and the wavelets emanating from these points spread out in all directions with the spread of the wave. Each point of the wavefront is the source of a</p>	(i) Statement of Huygens' Principle	$\frac{1}{2}$	Construction of reflected wave front	$\frac{1}{2}$	Proof of angle of reflection is equal to angle of incidence	1	(ii) Definition of coherent sources	$\frac{1}{2}$	Explanation	1	(iii) Finding the unknown wavelength	$1 \frac{1}{2}$		
(i) Statement of Huygens' Principle	$\frac{1}{2}$														
Construction of reflected wave front	$\frac{1}{2}$														
Proof of angle of reflection is equal to angle of incidence	1														
(ii) Definition of coherent sources	$\frac{1}{2}$														
Explanation	1														
(iii) Finding the unknown wavelength	$1 \frac{1}{2}$														

secondary disturbance and the wavelets emanating from these points spread out in all directions with the speed of the wave. These wavelets emanating from the wavefront are usually referred to as secondary wavelets and if we draw a common tangent to all these spheres, we obtain the new position of the wavefront at a later time.

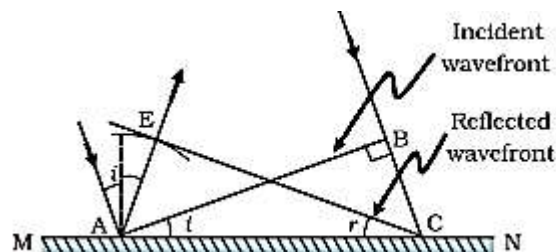

$\triangle EAC$ is congruent to $\triangle BAC$; so $\angle i = \angle r$

(ii) Two sources are said to be coherent if the phase difference between them does not change with time.

No, two independent sodium lamps cannot be coherent.

Two independent sodium lamps cannot be coherent as the phase between them does not remain constant with time.

(iii)

$$\begin{aligned}
 4\beta_2 &= 5\beta_1 \\
 4 \times \frac{\lambda D}{d} &= 5 \times \frac{\lambda_{\text{known}} D}{d} \\
 \Rightarrow \lambda &= \frac{5}{4} \times \lambda_{\text{known}} \\
 &= \frac{5}{4} \times 520 \\
 &= 650 \text{ nm}
 \end{aligned}$$

$\frac{1}{2}$

$\frac{1}{2}$

1

$\frac{1}{2}$

$\frac{1}{2}$

$\frac{1}{2}$

$\frac{1}{2}$

1

5

Marking Scheme
Strictly Confidential
(For Internal and Restricted use only)
Senior School Certificate Examination, 2024
SUBJECT NAME PHYSICS (Theory) (CODE 55/1/2)

General Instructions: -

1	You are aware that evaluation is the most important process in the actual and correct assessment of the candidates. A small mistake in evaluation may lead to serious problems which may affect the future of the candidates, education system and teaching profession. To avoid mistakes, it is requested that before starting evaluation, you must read and understand the spot evaluation guidelines carefully.
2	“Evaluation policy is a confidential policy as it is related to the confidentiality of the examinations conducted, Evaluation done and several other aspects. Its’ leakage to public in any manner could lead to derailment of the examination system and affect the life and future of millions of candidates. Sharing this policy/document to anyone, publishing in any magazine and printing in News Paper/Website etc may invite action under various rules of the Board and IPC.”
3	Evaluation is to be done as per instructions provided in the Marking Scheme. It should not be done according to one’s own interpretation or any other consideration. Marking Scheme should be strictly adhered to and religiously followed. However, while evaluating, answers which are based on latest information or knowledge and/or are innovative, they may be assessed for their correctness otherwise and due marks be awarded to them. In class-X, while evaluating two competency-based questions, please try to understand given answer and even if reply is not from marking scheme but correct competency is enumerated by the candidate, due marks should be awarded.
4	The Marking scheme carries only suggested value points for the answers These are in the nature of Guidelines only and do not constitute the complete answer. The students can have their own expression and if the expression is correct, the due marks should be awarded accordingly.
5	The Head-Examiner must go through the first five answer books evaluated by each evaluator on the first day, to ensure that evaluation has been carried out as per the instructions given in the Marking Scheme. If there is any variation, the same should be zero after deliberation and discussion. The remaining answer books meant for evaluation shall be given only after ensuring that there is no significant variation in the marking of individual evaluators.
6	Evaluators will mark(\surd) wherever answer is correct. For wrong answer CROSS ‘X’ be marked. Evaluators will not put right (\surd) while evaluating which gives an impression that answer is correct and no marks are awarded. This is most common mistake which evaluators are committing.
7	If a question has parts, please award marks on the right-hand side for each part. Marks awarded for different parts of the question should then be totaled up and written in the left-hand margin and encircled. This may be followed strictly.
8	If a question does not have any parts, marks must be awarded in the left-hand margin and encircled. This may also be followed strictly.



9	If a student has attempted an extra question, answer of the question deserving more marks should be retained and the other answer scored out with a note “ Extra Question ”.
10	No marks to be deducted for the cumulative effect of an error. It should be penalized only once.
11	A full scale of marks 0 to 70 has to be used. Please do not hesitate to award full marks if the answer deserves it.
12	Every examiner has to necessarily do evaluation work for full working hours i.e., 8 hours every day and evaluate 20 answer books per day in main subjects and 25 answer books per day in other subjects (Details are given in Spot Guidelines). This is in view of the reduced syllabus and number of questions in question paper.
13	<p>Ensure that you do not make the following common types of errors committed by the Examiner in the past:-</p> <ul style="list-style-type: none"> ● Leaving answer or part thereof unassessed in an answer book. ● Giving more marks for an answer than assigned to it. ● Wrong totaling of marks awarded on an answer. ● Wrong transfer of marks from the inside pages of the answer book to the title page. ● Wrong question wise totaling on the title page. ● Wrong totaling of marks of the two columns on the title page. ● Wrong grand total. ● Marks in words and figures not tallying/not same. ● Wrong transfer of marks from the answer book to online award list. ● Answers marked as correct, but marks not awarded. (Ensure that the right tick mark is correctly and clearly indicated. It should merely be a line. Same is with the X for incorrect answer.) ● Half or a part of answer marked correct and the rest as wrong, but no marks awarded.
14	While evaluating the answer books if the answer is found to be totally incorrect, it should be marked as cross (X) and awarded zero (0) Marks.
15	Any un assessed portion, non-carrying over of marks to the title page, or totaling error detected by the candidate shall damage the prestige of all the personnel engaged in the evaluation work as also of the Board. Hence, in order to uphold the prestige of all concerned, it is again reiterated that the instructions be followed meticulously and judiciously.
16	The Examiners should acquaint themselves with the guidelines given in the “ Guidelines for spot Evaluation ” before starting the actual evaluation.
17	Every Examiner shall also ensure that all the answers are evaluated, marks carried over to the title page, correctly totaled and written in figures and words.
18	The candidates are entitled to obtain photocopy of the Answer Book on request on payment of the prescribed processing fee. All Examiners/Additional Head Examiners/Head Examiners are once again reminded that they must ensure that evaluation is carried out strictly as per value points for each answer as given in the Marking Scheme.



MARKING SCHEME : PHYSICS (042)

CODE :55/1/2

Q.NO.	VALUE POINT/EXPECTED ANSWERS	MARKS	TOTAL MARKS
Section A			
1.	(B) Zero	1	1
2.	(A) 1	1	1
3.	(D) 2E and 4r	1	1
4.	(D) $\frac{1}{4}$	1	1
5.	(B) $(-0.8 \text{ mN}) \hat{i}$	1	1
6.	(B) $\frac{G}{1000} \Omega$	1	1
7.	(C) $4\pi\mu V$	1	1
8.	(A) In the same phase and perpendicular to each other	1	1
9.	(C) $\frac{1}{3}$	1	1
10.	(A) momentum	1	1
11.	(B) the number of conduction electrons increases.	1	1
12.	(C) $n_f = 2$ and $n_i = 4$	1	1
13.	(D) Assertion (A) is false and reason (R) is also false..	1	1
14.	(A) Both Assertion (A) and Reason (R) are true and Reason (R) is the correct explanation of the Assertion (A)	1	1
15.	(D) Assertion is false and Reason (R) is also false.	1	1
16.	(A) Both Assertion (A) and Reason(R) are true and Reason(R) is the correct explanation of the Assertion (A)	1	1
Section B			
17.	<div style="border: 1px solid black; padding: 5px; display: inline-block; width: 80%;"> Finding the value of R 2 </div> $i = \frac{9}{R+1}$ As potential difference across 6V is zero; $6 - ir = 0 \Rightarrow 6 - \left(\frac{9}{R+1}\right)(0.8) = 0$ On solving; $R = 0.2\Omega$	$\frac{1}{2}$ $\frac{1}{2}$ 1	2
18.	<div style="border: 1px solid black; padding: 5px; display: inline-block; width: 80%;"> Obtaining an expression for λ_n / λ_p 2 </div>		

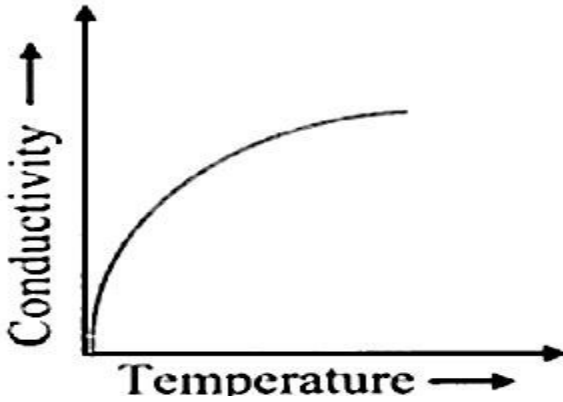
20.	<div style="border: 1px solid black; padding: 5px; margin-bottom: 10px;"> <p>Finding the</p> <p>(i) position of the image formed 1</p> <p>(ii) magnification of the image 1</p> </div> <p>(i) $\frac{1}{v} + \frac{1}{u} = \frac{1}{f}$</p> <p>$\frac{1}{v} + \frac{1}{-30} = \frac{1}{-20}$</p> <p>On solving $v = -60 \text{ cm}$</p> <p>(ii) $m = -\frac{v}{u}$ $= -\left(\frac{-60}{-30}\right) = -2$</p>	<p>$\frac{1}{2}$</p> <p>$\frac{1}{2}$</p> <p>$\frac{1}{2}$</p>	2
21.	<div style="border: 1px solid black; padding: 5px; margin-bottom: 10px;"> <p>Variation of conductivity of an intrinsic semiconductor with temperature and it's explanation $\frac{1}{2} + \frac{1}{2}$</p> <p>Graph showing variation of conductivity with temperature 1</p> </div> <p>Conductivity will increase.</p> <p>As the temperature increase , more thermal energy becomes available to these electrons and some of these electrons may break -away (becoming free electrons contributing to conduction)</p> <div style="text-align: center; margin-top: 20px;">  </div>	<p>$\frac{1}{2}$</p> <p>$\frac{1}{2}$</p> <p>1</p>	2

SECTION C

22.

Nature of Q_1	1
Value of Q_1	2

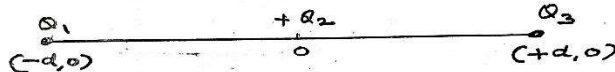

Nature of Q_1 will be negative.

Let , $Q_1 = Q_3 = q$

$$\frac{1}{4\pi\epsilon_0} \left[\frac{qQ_2}{d} + \frac{qq}{2d} + \frac{Q_2q}{d} \right] = 0$$

$$\frac{1}{4\pi\epsilon_0 d} \left[qQ_2 + \frac{q^2}{2} + Q_2q \right] = 0$$

$$2qQ_2 + \frac{q^2}{2} = 0$$

$$2qQ_2 = -\frac{q^2}{2}$$

$$Q_1 = q = -4Q_2$$

1

1/2

1/2

1

3

23.

a)

• Defining current density	1/2
• Whether scalar or vector	1/2
• Showing $\vec{j} = \alpha \vec{E}$	2

Current density is the amount of charge flowing per second per unit area normal to the flow.

Alternatively:

$$j = \frac{I}{A}$$

It is a vector quantity.

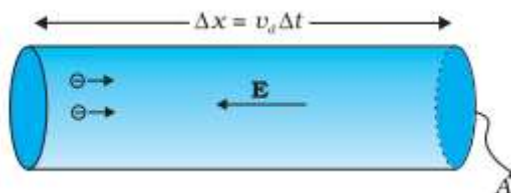

1/2

1/2

The amount of charge crossing the area A in time Δt is $I \Delta t$, where I is the magnitude of the current. Hence,

$$I \Delta t = ne A |v_d| \Delta t$$

$$I \Delta t = \frac{e^2 A}{m} \tau n \Delta t |E|$$

$$I = |j|A$$

$$|j| = \frac{ne^2}{m} \tau |E|$$

$$\vec{j} = \alpha \vec{E}$$

OR

b)

Defining Wheatstone bridge	1
Obtaining balancing conditions	2

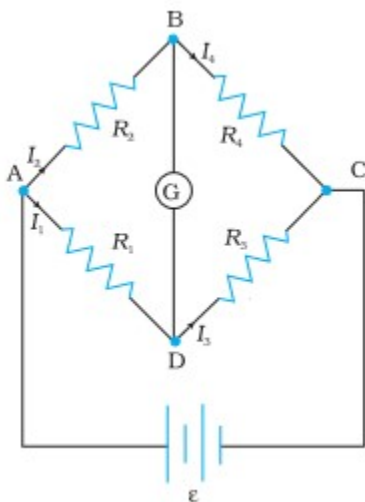

Alternatively:

If the figure is explained in words full credit to be given.

For loop ADBA:

$$-I_1 R_1 + I_2 R_2 + I_g G = 0 \quad (1)$$

For loop CBDC:

$$I_4 R_4 - I_3 R_3 - I_g G = 0 \quad (2)$$

For balanced wheatstone bridge, $I_g = 0$

And by applying Kirchoff's junction rule to junction D and B,

$$I_1 = I_3 \text{ \& } I_2 = I_4$$

½

½

½

½

1

½

½

½

	<p>From eqn (1) and (2)</p> $\frac{I_1}{I_2} = \frac{R_2}{R_1} \text{ and } \frac{I_1}{I_2} = \frac{R_4}{R_3}$ $\Rightarrow \frac{R_2}{R_1} = \frac{R_4}{R_3}$	<p>1/2</p>	<p>3</p>
<p>24.</p>	<div style="border: 1px solid black; padding: 5px; margin-bottom: 10px;"> <p>(a) Finding the work done to turn the magnet</p> <p>(i) normal to the field direction 1</p> <p>(ii) opposite to the field direction 1</p> <p>(b) Torque on the magnet for case (i) and (ii) 1/2 + 1/2</p> </div> <p>(a)</p> <p>(i)</p> $W = -mB(\cos\theta_2 - \cos\theta_1)$ $= -mB(\cos 90^\circ - \cos 0^\circ)$ $= mB$ $W = 2.5 \times 0.32$ $W = 0.8 \text{ J}$ <p>(ii)</p> $W = -mB(\cos 180^\circ - \cos 0^\circ)$ $= 2 mB$ $= 2 \times 0.8$ $W = 1.6 \text{ J}$ <p>(b)</p> <p>(i)</p> $\tau = mB \sin \theta$ $= 0.8 \text{ Nm}$ <p>(ii)</p> $\tau = 0$	<p>1</p> <p>1</p> <p>1/2</p> <p>1/2</p>	<p>3</p>
<p>25.</p>	<div style="border: 1px solid black; padding: 5px;"> <p>(a) Explaining the phenomenon 1</p> <p>(b) Two Factors on which current depends 1</p> <p>(c) Direction of current in coil Q when</p> <p>(i) R is increased 1/2</p> <p>(ii) R is decreased 1/2</p> </div>		

	<p>(a) Mutual Induction When an alternating voltage is applied to the primary, the resulting current produces an alternating magnetic flux which links the secondary and induces an emf in it.</p> <p>(b) Factors on which the current produced in coil Q depends will be: (Any two) (i) Number of turns in coil P and Q (ii) Current flowing through coil P. (iii) Resistance of coil Q. (iv) Mutual Induction between the two coils.</p> <p>(c) The direction of current through coil Q: (i) Clockwise when R is increased. (ii) Anticlockwise when R is decreased.</p>	<p>1</p> <p>$\frac{1}{2} + \frac{1}{2}$</p> <p>$\frac{1}{2}$ $\frac{1}{2}$</p>	<p>3</p>						
<p>26.</p>	<table border="1" data-bbox="289 747 1154 926"> <tr> <td>• Drawbacks of Rutherford's atomic model</td> <td>1</td> </tr> <tr> <td>• Bohr's explanation</td> <td>1</td> </tr> <tr> <td>• Showing different orbits are not equally spaced</td> <td>1</td> </tr> </table> <p>Drawbacks: i) According to classical electromagnetic theory, an accelerating charged particle emits radiation in the form of electromagnetic waves. The energy of an accelerating electron should therefore, continuously decrease. The electron would spiral inward and eventually fall into the nucleus. Thus, such an atom cannot be stable. ii) As the electrons spiral inwards, their angular velocities and hence their frequencies would change continuously. Thus, they would emit a continuous spectrum, in contradiction to the line spectrum actually observed.</p> <p>Bohr postulated stable orbits in which electrons do not radiate energy</p> <p>Alternatively: Bohr's postulates (Any ONE of the three) (i) An electron in an atom could revolve in certain stable orbits without the emission of radiant energy. (ii) The electron revolves around the nucleus only in those orbits for which the angular momentum is some integral multiple of $h/2\pi$ (iii) An electron might make a transition from one of its specified non-radiating orbits to another of lower energy. When it does so, a photon is emitted having energy equal to the energy difference between the initial and final states.</p>	• Drawbacks of Rutherford's atomic model	1	• Bohr's explanation	1	• Showing different orbits are not equally spaced	1	<p>1</p> <p>1</p>	
• Drawbacks of Rutherford's atomic model	1								
• Bohr's explanation	1								
• Showing different orbits are not equally spaced	1								

	<p>The radius of the n^{th} orbit is found as</p> $r_n = \left(\frac{n^2}{m}\right) \left(\frac{h}{2\pi}\right)^2 \frac{4\pi\epsilon_0}{e^2}$ $r_n \propto n^2$ <p>Alternatively: Difference in radius of consecutive orbits is $r_{n+1} - r_n = k [(n+1)^2 - n^2]$ $= k (2n + 1)$ which depends on n, and is not a constant</p>	1	3						
27.	<table border="1" style="margin-left: auto; margin-right: auto;"> <tr> <td>a) Two examples</td> <td style="text-align: right;">1</td> </tr> <tr> <td>b) (i) Reason for use of short waves bands</td> <td style="text-align: right;">1</td> </tr> <tr> <td> (ii) Reason for x-ray astronomy from satellites</td> <td style="text-align: right;">1</td> </tr> </table> <p>a) (Any Two)</p> <ul style="list-style-type: none"> • Gamma radiation having wavelength of 10^{-14} m to 10^{-15} m, typically originate from an atomic nucleus. • X-rays are emitted from heavy atoms. • Radio waves are produced by accelerating electrons in a circuit. A transmitting antenna can most efficiently radiate waves having a wavelength of about the same size as the antenna. <p>b) (i) Ionosphere reflects waves in these bands (ii) Atmosphere absorbs x-rays, while visible and radio waves can penetrate it.</p> <p>Note: Full credit to be given for part (b) for mere attempt.</p>	a) Two examples	1	b) (i) Reason for use of short waves bands	1	(ii) Reason for x-ray astronomy from satellites	1	$\frac{1}{2} + \frac{1}{2}$ 1 1	3
a) Two examples	1								
b) (i) Reason for use of short waves bands	1								
(ii) Reason for x-ray astronomy from satellites	1								
28.	<table border="1" style="margin-left: auto; margin-right: auto;"> <tr> <td>(a) Two properties of nuclear force</td> <td style="text-align: right;">1</td> </tr> <tr> <td>(b) Plotting graph between potential energy as a function of separation.</td> <td style="text-align: right;">1</td> </tr> <tr> <td>Two important conclusions.</td> <td style="text-align: right;">1</td> </tr> </table> <p>(a) Properties of nuclear forces (Any two) :</p> <ol style="list-style-type: none"> (i) The nuclear force is much stronger than the Coulomb force acting between charges or the gravitational forces between their masses. (ii) The nuclear force between two nucleons falls rapidly to zero as their distance becomes more than a few femtometres. (iii) The nuclear force between neutron- neutron, proton- neutron 	(a) Two properties of nuclear force	1	(b) Plotting graph between potential energy as a function of separation.	1	Two important conclusions.	1		
(a) Two properties of nuclear force	1								
(b) Plotting graph between potential energy as a function of separation.	1								
Two important conclusions.	1								

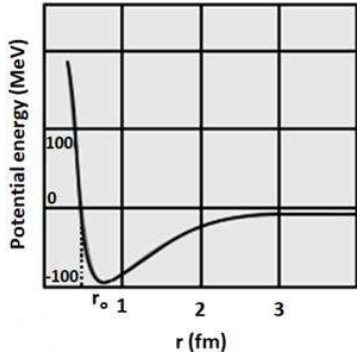
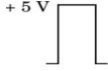
	<p>and proton-proton is approximately same.</p> <p>(iv) The nuclear force is charge independent.</p> <p>(b)</p>  <p>Note: Full credit to be given if values are not marked on the graph.</p> <p>Conclusions:-</p> <p>(i) The potential energy is minimum at a distance r_0.</p> <p>(ii) The force between the nucleons is attractive for distances larger than r_0 and repulsive if they are separated by distance less than r_0.</p>	<p>$\frac{1}{2} + \frac{1}{2}$</p> <p>1</p> <p>$\frac{1}{2} + \frac{1}{2}$</p>	<p>3</p>
<u>Section D</u>			
29.	<p>(i) (A) $\frac{V_0}{\sqrt{2}}$</p> <p>(ii) (B) half cycle of the input signal</p> <p>(iii) (C) One is forward biased and the other is reverse biased at the same time</p> <p>(iv) a) (B) 50 Hz</p> <p>OR</p> <p>b) (D) </p>	<p>1</p> <p>1</p> <p>1</p> <p>1</p>	<p>4</p>
30.	<p>(i) (A) $\frac{2(n-1)}{R}$</p> <p>(ii) (D) $P/2$</p> <p>(iii) (B) P</p> <p>(iv) a) (C) 2P</p> <p>OR</p> <p>b) (A) 6.6 D</p>	<p>1</p> <p>1</p> <p>1</p> <p>1</p>	<p>4</p>

Section E

31.

(a)	(i) Graph showing variation of angle of deviation with angle of incidence	1
	Defining angle of minimum deviation	1
	(ii) Proof of refractive index $n = \frac{\sin(A + \delta)}{\sin A}$	1
	(iii) (1) Finding angle of minimum deviation	1
	(2) Angle of Incidence	1

(i)

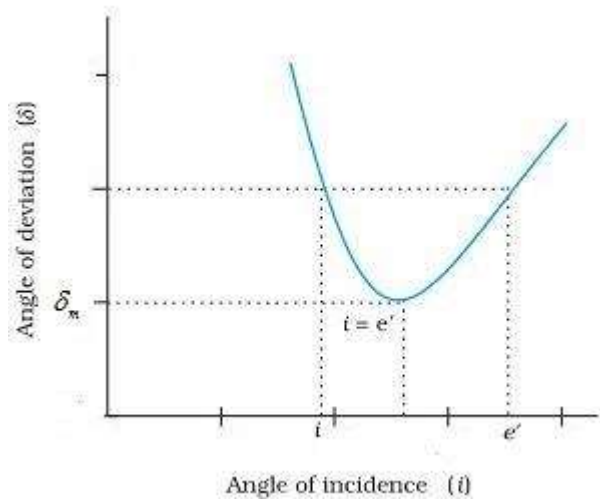

Minimum deviation angle is defined as the angle at which angle of incidence is equal to the angle of emergence.

Alternatively

At minimum deviation refracted ray inside the prism becomes parallel to the base of the prism.

1

1

(ii)

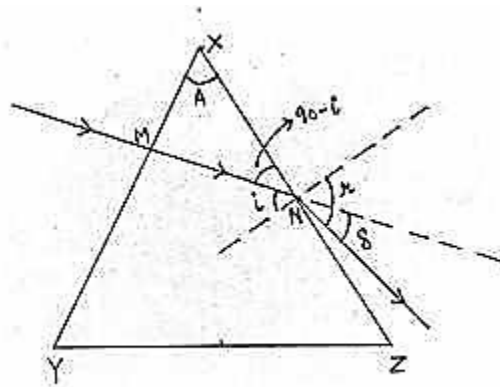

At the face XZ :-

$$\mu \sin i = 1 \times \sin r \quad \text{----- (1)}$$

$$r = i + \delta \quad \text{[from diagram] ----- (2)}$$

$$\begin{aligned} \text{In } \triangle XMN; \quad A + (90 - i) + 90 &= 180 \\ \Rightarrow A &= i \quad \text{----- (3)} \end{aligned}$$

Putting eq. (3) & (2) in eq. (1)

$$\mu \sin A = \sin (A + \delta)$$

$$\mu = \frac{\sin (A + \delta)}{\sin A}$$

(iii)

$$(1) \quad \mu = \frac{\sin \left(\frac{A + \delta_m}{2} \right)}{\sin \frac{A}{2}}$$

$$\sqrt{2} = \frac{\sin \left(\frac{60 + \delta_m}{2} \right)}{\sin 30^\circ}$$

$$\Rightarrow \sin \left(\frac{60 + \delta_m}{2} \right) = \frac{1}{\sqrt{2}} = \sin 45^\circ$$

$$\frac{60 + \delta_m}{2} = 45^\circ \Rightarrow \delta_m = 30^\circ$$

$$(2) \quad i = \frac{A + \delta_m}{2}$$

$$\Rightarrow i = \frac{60 + 30}{2}$$

$$i = 45^\circ$$

1/2

1/2

1/2

1/2

1/2

1/2

OR

(b)

(i) Statement of Huygens' Principle	½
Construction of reflected wave front	½
Proof of angle of reflection is equal to angle of incidence	1
(ii) Definition of coherent sources	½
Explanation	1
(iii) Finding the unknown wavelength	1 ½

(i) Each point of the wavefront is the source of a secondary disturbance and the wavelets emanating from these points spread out in all directions with the speed of the wave. Each point of the wavefront is the source of a secondary disturbance and the wavelets emanating from these points spread out in all directions with the speed of the wave. These wavelets emanating from the wavefront are usually referred to as secondary wavelets and if we draw a common tangent to all these spheres, we obtain the new position of the wavefront at a later time.

½

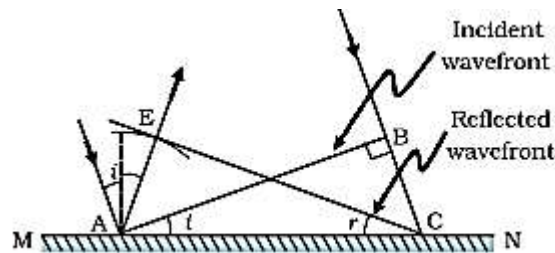

½

ΔEAC is congruent to ΔBAC ; so $\angle i = \angle r$

1

(ii) Two sources are said to be coherent if the phase difference between them does not change with time.

½

No, two independent sodium lamps cannot be coherent.

½

Two independent sodium lamps cannot be coherent as the phase between them does not remain constant with time.

½

(iii)

$$4\beta_2 = 5\beta_1$$

$$4 \times \frac{\lambda D}{d} = 5 \times \frac{\lambda_{\text{known}} D}{d}$$

½



$$\begin{aligned} \Rightarrow \lambda &= \frac{5}{4} \times \lambda_{\text{known}} \\ &= \frac{5}{4} \times 520 \\ &= 650 \text{ nm} \end{aligned}$$

1

5

32.

(a)

(i)

- Deriving the expression for potential energy 2
- Maximum & Minimum value of potential energy ($\frac{1}{2} + \frac{1}{2}$)

(ii) Finding the torque. 2

(i)

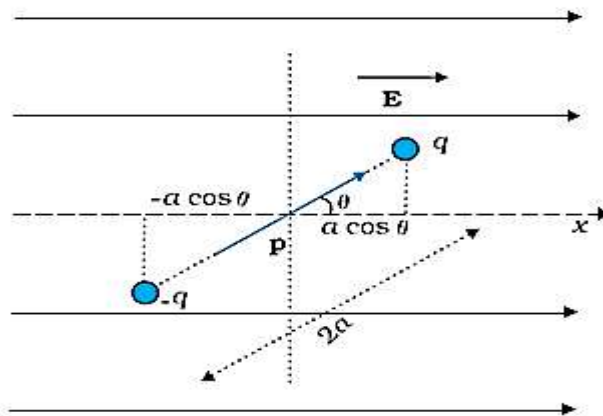

The amount of work done in rotating the dipole from $\theta = \theta_0$ to $\theta = \theta_1$ by the external torque

$$W = \int_{\theta_0}^{\theta_1} \tau_{\text{ext}} d\theta$$

$$= \int_{\theta_0}^{\theta_1} pE \sin \theta d\theta$$

$$W = pE(\cos \theta_0 - \cos \theta_1)$$

For $\theta_0 = \frac{\pi}{2}$ & $\theta_1 = \theta$

$$= pE(\cos \frac{\pi}{2} - \cos \theta)$$

$$U(\theta) = -pE \cos \theta$$

$$= -\vec{p} \cdot \vec{E}$$

(1) Potential energy is maximum when:

\vec{p} is antiparallel to \vec{E}

 $\frac{1}{2}$ $\frac{1}{2}$ $\frac{1}{2}$ $\frac{1}{2}$ $\frac{1}{2}$

	<p>Alternatively: $\theta = 180^\circ$ or π radians (2) Potential energy is minimum when: \vec{p} is along to \vec{E} Alternatively: $\theta = 0^\circ$</p>	$\frac{1}{2}$	
--	---	---------------	--

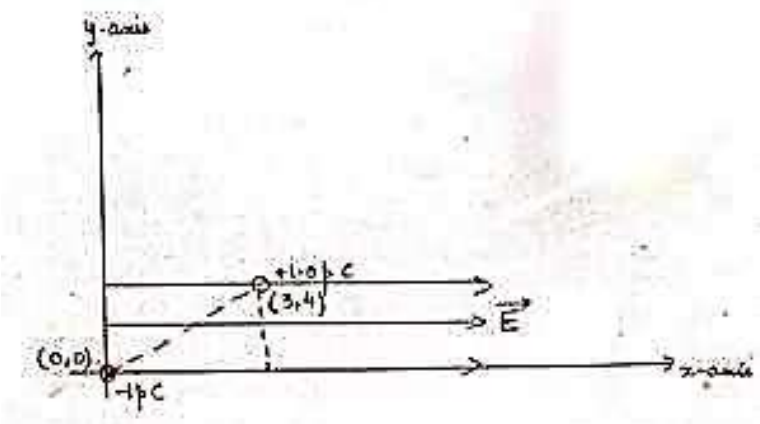
(ii)	 <p> $\tau = pE \sin \theta$ $= (2aq)E \sin \theta$ $= (5 \times 10^{-3} \times 1 \times 10^{-12}) 10^3 \times \frac{4}{5}$ $= 4 \times 10^{-12} \text{ Nm}$ Direction is along -ve Z direction. </p>	$\frac{1}{2}$ $\frac{1}{2}$ $\frac{1}{2}$ $\frac{1}{2}$	
------	---	--	--

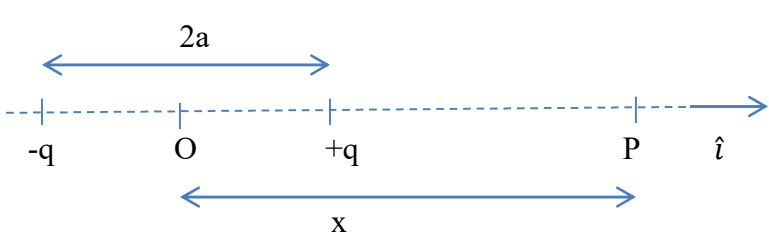
OR							
(b)	<table border="1" style="width: 100%; border-collapse: collapse;"> <tr> <td style="padding: 5px;">(i) Deriving expression for potential</td> <td style="text-align: right; padding: 5px;">2 ½</td> </tr> <tr> <td style="padding: 5px;">(ii) New charge on Sphere S_1</td> <td style="text-align: right; padding: 5px;">2 ½</td> </tr> </table> <p>(i)</p> 	(i) Deriving expression for potential	2 ½	(ii) New charge on Sphere S_1	2 ½	$\frac{1}{2}$	
(i) Deriving expression for potential	2 ½						
(ii) New charge on Sphere S_1	2 ½						

$$V = \frac{1}{4\pi\epsilon_0} \frac{q}{r}$$

$$V = V_{+q} - V_{-q}$$

$$V = \frac{1}{4\pi\epsilon_0} \left[\frac{q}{(x-a)} - \frac{q}{(x+a)} \right]$$

$$= \frac{q}{4\pi\epsilon_0} \left[\frac{x+a-x+a}{(x^2-a^2)} \right]$$

$$V = \frac{q}{4\pi\epsilon_0} \frac{2a}{(x^2-a^2)} = \frac{p}{4\pi\epsilon_0(x^2-a^2)}$$

As p is along x-axis, so

$$V = \frac{1}{4\pi\epsilon_0} \frac{\vec{p} \cdot \hat{i}}{(x^2-a^2)}$$

If $x \gg a$

$$V = \frac{1}{4\pi\epsilon_0} \frac{\vec{p} \cdot \hat{i}}{x^2}$$

1/2

1/2

1/2

1/2

Alternatively:

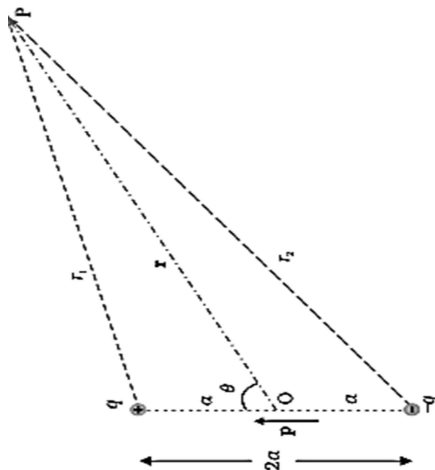

$$V = \frac{1}{4\pi\epsilon_0} \left(\frac{q}{r_1} - \frac{q}{r_2} \right) \quad \text{----- (i)}$$

By geometry

$$r_1^2 = r^2 + a^2 - 2ar \cos\theta$$

$$r_2^2 = r^2 + a^2 + 2ar \cos\theta$$

$$r_1^2 = r^2 \left(1 - \frac{2a \cos\theta}{r} + \frac{a^2}{r^2} \right)$$

1/2

	$\cong r^2 \left(1 - \frac{2a \cos \theta}{r} \right)$ $r_2^2 \cong r^2 \left(1 + \frac{2a \cos \theta}{r} \right)$ <p>Similarly,</p> <p>Using binomial theorem & retaining terms upto the first order in $\frac{a}{r}$;</p> <p>we obtain</p> $\frac{1}{r_1} \cong \frac{1}{r} \left(1 - \frac{2a \cos \theta}{r} \right)^{-\frac{1}{2}} \cong \frac{1}{r} \left(1 + \frac{a}{r} \cos \theta \right) \quad \text{----- (ii)}$ $\frac{1}{r_2} \cong \frac{1}{r} \left(1 - \frac{2a \cos \theta}{r} \right)^{-\frac{1}{2}} \cong \frac{1}{r} \left(1 - \frac{a}{r} \cos \theta \right) \quad \text{----- (iii)}$ <p>Using equations (i) ,(ii) & (iii) & $p = 2qa$</p> $V = \frac{q}{4\pi\epsilon_0} \frac{2a \cos \theta}{r^2} = \frac{p \cos \theta}{4\pi\epsilon_0 r^2}$ $p \cos \theta = \vec{p} \cdot \hat{r}$ <p>As \vec{r} is along the x – axis.</p> $\Rightarrow \vec{p} \cdot \hat{r} = \vec{p} \cdot \hat{i}$ $\Rightarrow V = \frac{1}{4\pi\epsilon_0} \frac{\vec{p} \cdot \hat{i}}{x^2}$	<p>$\frac{1}{2}$</p> <p>$\frac{1}{2}$</p> <p>$\frac{1}{2}$</p> <p>$\frac{1}{2}$</p>	
	<p>(ii)</p> <p>Charge on sphere S_1 :</p> $Q_1 = \text{surface charge density} \times \text{surface Area}$ $= \left(\frac{2}{\pi} \times 10^{-9} \right) \times 4\pi (1 \times 10^{-2})^2$ $= 8 \times 10^{-13} \text{ C}$ <p>Charge on sphere S_2 :</p> $Q_2 = \text{surface charge density} \times \text{surface Area}$ $= \left(\frac{2}{\pi} \times 10^{-9} \right) \times 4\pi (3 \times 10^{-2})^2$ $= 72 \times 10^{-13} \text{ C}$ <p>When connected by a thin wire they acquire a common potential V and the charge remains conserved.</p> $Q_1 + Q_2 = Q'_1 + Q'_2$ $= C_1 V + C_2 V$ $Q_1 + Q_2 = (C_1 + C_2) V$	<p>$\frac{1}{2}$</p> <p>$\frac{1}{2}$</p> <p>$\frac{1}{2}$</p>	

	<p>Common potential(V) = $\frac{Q_1 + Q_2}{C_1 + C_2}$</p> <p>$C_1 = 4\pi\epsilon_0 r_1 = \frac{1}{9 \times 10^9} \times 10^{-2} = \frac{1}{9} \times 10^{-11} F$</p> <p>$C_2 = 4\pi\epsilon_0 r_2 = \frac{1}{9 \times 10^9} \times 3 \times 10^{-2} = \frac{1}{3} \times 10^{-11} F$</p> <p>$V = \frac{80 \times 10^{-13}}{\left(\frac{1}{9} + \frac{1}{3}\right) \times 10^{-11}} = 1.8 V$</p> <p>$Q'_1 = C_1 V = \frac{1}{9} \times 10^{-11} \times 1.8$</p> <p>$Q'_1 = 2 \times 10^{-12} C$</p> <p>Alternatively:</p> <p>Charge on sphere S₁ :</p> <p>$Q_1 = \text{surface charge density} \times \text{surface Area}$</p> <p>$= \left(\frac{2}{\pi} \times 10^{-9}\right) \times 4\pi (1 \times 10^{-2})^2$</p> <p>$= 8 \times 10^{-13} C$</p> <p>Charge on sphere S₂ :</p> <p>$Q_2 = \text{surface charge density} \times \text{surface Area}$</p> <p>$= \left(\frac{2}{\pi} \times 10^{-9}\right) \times 4\pi (3 \times 10^{-2})^2$</p> <p>$= 72 \times 10^{-13} C$</p> <p>When connected by a thin wire they acquire a common potential V and the charge remains conserved.</p> <p>$Q_1 + Q_2 = Q'_1 + Q'_2$</p> <p>$\frac{Q'_2}{Q'_1} = \frac{r_2}{r_1}$</p> <p>On solving, $Q'_1 = 2 \times 10^{-12} C$</p>	<p>½</p> <p>½</p> <p>½</p> <p>½</p> <p>½</p> <p>½</p> <p>½</p>	<p>5</p>						
<p>33.</p>	<p>(a)</p> <table border="1" data-bbox="354 1570 1127 1709"> <tbody> <tr> <td>(i) Deriving expression for impedance</td> <td>2</td> </tr> <tr> <td>(ii) Reason</td> <td>1</td> </tr> <tr> <td>(iii) Inductance of coil</td> <td>2</td> </tr> </tbody> </table>	(i) Deriving expression for impedance	2	(ii) Reason	1	(iii) Inductance of coil	2		
(i) Deriving expression for impedance	2								
(ii) Reason	1								
(iii) Inductance of coil	2								

(i)

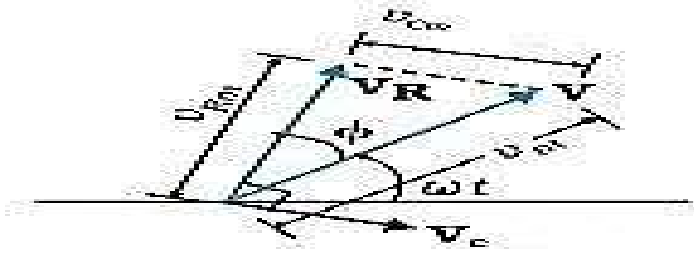

$$V_C + V_R = V$$

$$v_m^2 = v_{rm}^2 + v_{cm}^2$$

$$v_{rm} = i_m R$$

$$v_{cm} = i_m X_c$$

$$v_m^2 = (i_m R)^2 + (i_m X_c)^2$$
$$= i_m^2 [R^2 + X_c^2]$$

$$\Rightarrow i_m = \frac{v_m}{\sqrt{R^2 + X_c^2}}$$

$$\Rightarrow \text{Impedance } Z = \sqrt{R^2 + X_c^2}$$

(ii) For direct current (dc), an inductor behaves as a conductor.

$$\text{As } X_L = \omega L = 2\pi \nu L$$

$$\text{For dc } \nu = 0 \Rightarrow X_L = 0$$

Alternatively: -

$$\text{Induced emf } (\mathcal{E}) = - \frac{L di}{dt}$$

$$\text{For dc; } di = 0 \Rightarrow \mathcal{E} = 0$$

$$\text{(iii) } R = \frac{110}{11} = 10 \Omega$$

$$i_{rms} = \frac{v_{rms}}{\sqrt{R^2 + X_L^2}} = \frac{220}{\sqrt{100 + X_L^2}}$$

$$11 = \frac{220}{\sqrt{100 + X_L^2}}$$

$$\sqrt{100 + X_L^2} = \frac{220}{11} = 20 \Omega$$

Squaring both sides:

$$\Rightarrow 100 + X_L^2 = 400$$

1/2

1/2

1/2

1/2

1

1/2

1/2



$$\Rightarrow X_L^2 = 300 \Rightarrow X_L = 10\sqrt{3} \Omega$$

$$X_L = 2\pi fL \Rightarrow 10\sqrt{3} = 2\pi \times 50 \times L$$

$$L = \frac{\sqrt{3}}{10\pi} H$$

OR

½

½

(b)

(i) Labelled diagram of step – up transformer	1
Describing working principle	½
Three causes	1 ½
(ii) Explanation	1
(iii) (1) Output voltage across secondary coil	½
(2) Current in primary coil	½

(i)

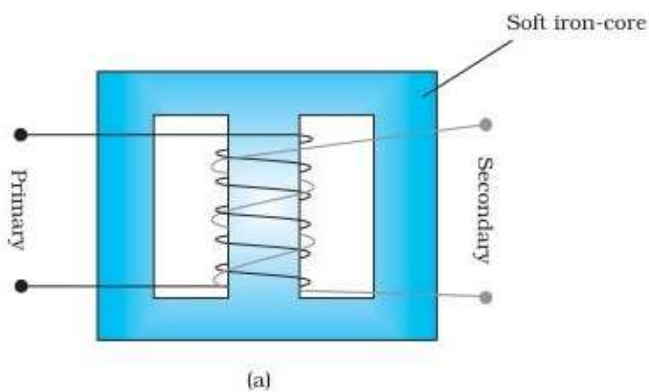

OR

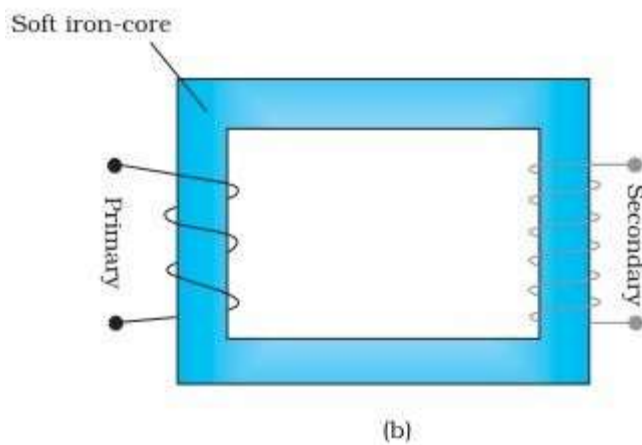

1

	<p>The working principle of transformer is mutual induction. When an alternating voltage is applied to the primary, the resulting current produces an alternating magnetic flux which links the secondary and induces an emf in it.</p> <p>Causes of energy losses (Any three)</p> <p>(a) Flux leakage (b) Resistance of the windings (c) Eddy currents (d) Hysteresis</p> <p>(ii) No Current changes correspondingly. So, the input power is equal to the output power.</p> <p>(iii)</p> <p>(1)</p> $\frac{V_s}{V_p} = \frac{N_s}{N_p}$ $V_s = \frac{N_s}{N_p} \times V_p = \frac{3000}{200} \times 90$ $V_s = 1350 \text{ V}$ <p>(2)</p> $\frac{I_p}{I_s} = \frac{N_s}{N_p}$ $I_p = \frac{3000}{200} \times 2 = 30 \text{ A}$	<p>$\frac{1}{2}$</p> <p>$\frac{1}{2} + \frac{1}{2} + \frac{1}{2}$</p> <p>$\frac{1}{2}$</p> <p>$\frac{1}{2}$</p> <p>$\frac{1}{2}$</p> <p>$\frac{1}{2}$</p>	<p>5</p>
--	---	---	----------

Marking Scheme
Strictly Confidential
(For Internal and Restricted use only)
Senior School Certificate Examination, 2024
SUBJECT NAME PHYSICS (Theory) (CODE 55/1/3)

General Instructions: -

1	You are aware that evaluation is the most important process in the actual and correct assessment of the candidates. A small mistake in evaluation may lead to serious problems which may affect the future of the candidates, education system and teaching profession. To avoid mistakes, it is requested that before starting evaluation, you must read and understand the spot evaluation guidelines carefully.
2	“Evaluation policy is a confidential policy as it is related to the confidentiality of the examinations conducted, Evaluation done and several other aspects. Its’ leakage to public in any manner could lead to derailment of the examination system and affect the life and future of millions of candidates. Sharing this policy/document to anyone, publishing in any magazine and printing in News Paper/Website etc may invite action under various rules of the Board and IPC.”
3	Evaluation is to be done as per instructions provided in the Marking Scheme. It should not be done according to one’s own interpretation or any other consideration. Marking Scheme should be strictly adhered to and religiously followed. However, while evaluating, answers which are based on latest information or knowledge and/or are innovative, they may be assessed for their correctness otherwise and due marks be awarded to them. In class-X, while evaluating two competency-based questions, please try to understand given answer and even if reply is not from marking scheme but correct competency is enumerated by the candidate, due marks should be awarded.
4	The Marking scheme carries only suggested value points for the answers These are in the nature of Guidelines only and do not constitute the complete answer. The students can have their own expression and if the expression is correct, the due marks should be awarded accordingly.
5	The Head-Examiner must go through the first five answer books evaluated by each evaluator on the first day, to ensure that evaluation has been carried out as per the instructions given in the Marking Scheme. If there is any variation, the same should be zero after deliberation and discussion. The remaining answer books meant for evaluation shall be given only after ensuring that there is no significant variation in the marking of individual evaluators.
6	Evaluators will mark(✓) wherever answer is correct. For wrong answer CROSS ‘X’ be marked. Evaluators will not put right (✓) while evaluating which gives an impression that answer is correct and no marks are awarded. This is most common mistake which evaluators are committing.
7	If a question has parts, please award marks on the right-hand side for each part. Marks awarded for different parts of the question should then be totaled up and written in the left-hand margin and encircled. This may be followed strictly.
8	If a question does not have any parts, marks must be awarded in the left-hand margin and encircled. This may also be followed strictly.



9	If a student has attempted an extra question, answer of the question deserving more marks should be retained and the other answer scored out with a note “ Extra Question ”.
10	No marks to be deducted for the cumulative effect of an error. It should be penalized only once.
11	A full scale of marks ___0 to 70___ (example 0 to 80/70/60/50/40/30 marks as given in Question Paper) has to be used. Please do not hesitate to award full marks if the answer deserves it.
12	Every examiner has to necessarily do evaluation work for full working hours i.e., 8 hours every day and evaluate 20 answer books per day in main subjects and 25 answer books per day in other subjects (Details are given in Spot Guidelines). This is in view of the reduced syllabus and number of questions in question paper.
13	Ensure that you do not make the following common types of errors committed by the Examiner in the past:- <ul style="list-style-type: none"> ● Leaving answer or part thereof unassessed in an answer book. ● Giving more marks for an answer than assigned to it. ● Wrong totaling of marks awarded on an answer. ● Wrong transfer of marks from the inside pages of the answer book to the title page. ● Wrong question wise totaling on the title page. ● Wrong totaling of marks of the two columns on the title page. ● Wrong grand total. ● Marks in words and figures not tallying/not same. ● Wrong transfer of marks from the answer book to online award list. ● Answers marked as correct, but marks not awarded. (Ensure that the right tick mark is correctly and clearly indicated. It should merely be a line. Same is with the X for incorrect answer.) ● Half or a part of answer marked correct and the rest as wrong, but no marks awarded.
14	While evaluating the answer books if the answer is found to be totally incorrect, it should be marked as cross (X) and awarded zero (0) Marks.
15	Any un assessed portion, non-carrying over of marks to the title page, or totaling error detected by the candidate shall damage the prestige of all the personnel engaged in the evaluation work as also of the Board. Hence, in order to uphold the prestige of all concerned, it is again reiterated that the instructions be followed meticulously and judiciously.
16	The Examiners should acquaint themselves with the guidelines given in the “ Guidelines for spot Evaluation ” before starting the actual evaluation.
17	Every Examiner shall also ensure that all the answers are evaluated, marks carried over to the title page, correctly totaled and written in figures and words.
18	The candidates are entitled to obtain photocopy of the Answer Book on request on payment of the prescribed processing fee. All Examiners/Additional Head Examiners/Head Examiners are once again reminded that they must ensure that evaluation is carried out strictly as per value points for each answer as given in the Marking Scheme.



MARKING SCHEME : PHYSICS (042)

CODE :55/1/3

Q.NO.	VALUE POINT/EXPECTED ANSWERS	MARKS	TOTAL MARKS
<u>SECTION A</u>			
1.	(B) Zero	1	1
2.	(B) B	1	1
3.	(B) \vec{E} and \vec{j} both are along -x direction	1	1
4.	(C) $\left(\frac{a}{b}\right)^2$	1	1
5.	(B) $\frac{G}{1000}\Omega$	1	1
6.	(B) $(-0.8 \text{ mN})\hat{i}$	1	1
7.	(D) 2200V - 50 HZ	1	1
8.	(C) J.C. Bose	1	1
9.	(A) momentum	1	1
10.	(C) $\frac{1}{3}$	1	1
11.	(C) $n_f = 2$ and $n_i = 4$	1	1
12.	(B) the number of conduction electrons increases	1	1
13.	(A) Both Assertion (A) and Reason (R) are true and Reason (R) is the correct explanation of the Assertion (A)	1	1
14.	(D) Assertion (A) is false and reason (R) is also false.	1	1
15.	(A) Assertion(A) is true , Reason (R) is true and Reason (R) is correct explanation of the Assertion (A)	1	1
16.	(D) Assertion (A) is false and Reason (R) is also false.	1	1
<u>SECTION B</u>			
17.	<div style="border: 1px solid black; padding: 5px; margin-bottom: 10px;"> Calculating the percentage increase in the resistance 2 </div> As the wire is uniformly stretched; $\Rightarrow Al = A'l' \Rightarrow A' = \frac{lA}{1.25l}$ $A' = \frac{4}{5}A$ $R' = \frac{\rho l'}{A'} = \frac{\rho(1.25l)}{\frac{4}{5}A}$ $R' = \frac{25}{16}R$	<p align="center">$\frac{1}{2}$</p> <p align="center">1</p>	

	<p>(a)</p> <p>(i)</p> $v = \nu \lambda$ $3 \times 10^8 = 5 \times 10^{14} \times \lambda$ $\lambda = 600 \text{ nm or } 6 \times 10^{-7} \text{ m}$ <p>(ii)</p> $\lambda_{\text{medium}} = \frac{\lambda_{\text{air}}}{\mu}$ $\lambda_{\text{medium}} = \frac{600 \text{ nm}}{1.5}$ $= 400 \text{ nm or } 4 \times 10^{-7} \text{ m}$ <p style="text-align: center;">OR</p> <p>(b)</p> <div style="border: 1px solid black; padding: 5px; margin: 10px auto; width: fit-content;"> Calculating the radius of the curved surface 2 </div> $\frac{1}{f} = (\mu - 1) \left(\frac{1}{R_1} - \frac{1}{R_2} \right)$ $\frac{1}{16} = (1.4 - 1) \left(\frac{1}{R} - \frac{1}{\infty} \right)$ $\frac{1}{16} = 0.4 \times \frac{1}{R}$ $R = 16 \times 0.4$ $R = 6.4 \text{ cm}$	<p>1</p> <p>1</p> <p>1</p> <p>1</p>	<p>2</p>
<p>21.</p>	<div style="border: 1px solid black; padding: 5px; margin-bottom: 10px;"> Differentiating between diffusion & drift current 1 Explaining their role in p-n junction 1 </div> <p>Diffusion current: It is due to the flow of majority charge carriers. Drift current: It is due to the flow of minority charge carriers.</p> <p>Due to the concentration gradient across p- , and n- sides, holes diffuse from p- side to n- side & electrons diffuse from n-side to p- side. This motion of charge carriers gives rise to diffusion current across the junction.</p> <p>Due to the positive space- charge region on n-side and negative space – charge region on p-side, an electric field directed from positive charge towards negative charge develops. Due to this field, motion of charge carriers comes into play giving rise to drift current.</p>	<p>1</p> <p>1</p>	<p>2</p>

SECTION C

22.

Calculating the amount of work done	3
-------------------------------------	---

$$C = \frac{A\epsilon_0}{d}; \quad C' = \frac{A\epsilon_0}{d'}$$

$$\Rightarrow \frac{C'}{C} = \frac{d}{d'} \Rightarrow C' = \frac{1}{5} \times 20$$

$$C' = 4\text{pF}$$

Work done = change in energy

$$= \frac{1}{2} \frac{Q^2}{C'} - \frac{1}{2} \frac{Q^2}{C}$$

$$= \frac{Q^2}{2} \left[\frac{1}{4} - \frac{1}{20} \right] \times 10^{12}$$

On solving ;

$$\text{Work done} = \frac{8}{5} J$$

$$= 1.6J$$

1

1

1

3

23.

a)

- | | |
|--------------------------------------|---------------|
| • Defining current density | $\frac{1}{2}$ |
| • Whether scalar or vector | $\frac{1}{2}$ |
| • Showing $\vec{j} = \alpha \vec{E}$ | 2 |

Current density is the amount of charge flowing per second per unit area normal to the flow.

Alternatively:

$$\vec{j} = \frac{I}{A}$$

It is a vector quantity.

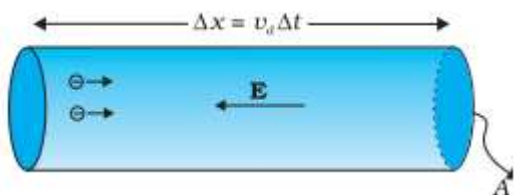

The amount of charge crossing the area A in time Δt is $I \Delta t$, where I is the magnitude of the current. Hence,

$\frac{1}{2}$

$\frac{1}{2}$

$$I \Delta t = ne A |v_d| \Delta t$$

$$I \Delta t = \frac{e^2 A}{m} \tau n \Delta t |E|$$

$$I = |j|A$$

$$|j| = \frac{ne^2}{m} \tau |E|$$

$$\vec{j} = \alpha \vec{E}$$

OR

b)

Defining Wheatstone bridge	1
Obtaining balancing conditions	2

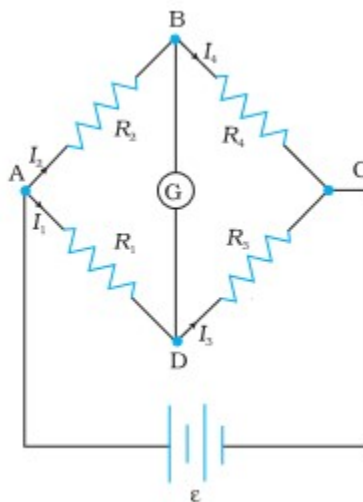

Alternatively:

If the figure is explained in words full credit to be given.

For loop ADBA:

$$-I_1 R_1 + I_2 R_2 + I_g G = 0 \quad (1)$$

For loop CBDC:

$$I_4 R_4 - I_3 R_3 - I_g G = 0 \quad (2)$$

For balanced wheatstone bridge, $I_g = 0$

And by applying Kirchoff's junction rule to junction D and B,

$$I_1 = I_3 \text{ \& } I_2 = I_4$$

1/2

1/2

1/2

1/2

1

1/2

1/2

1/2

	$v_d = \frac{I}{neA}$ $f_{avg} = e \times \frac{I}{neA} B$ $= \frac{IB}{nA}$ $= \frac{4 \times 0.5}{10^{28} \times 0.2 \times 10^{-4}}$ $= 10^{-23} \text{ N}$	$\frac{1}{2}$	3
--	--	---------------	---

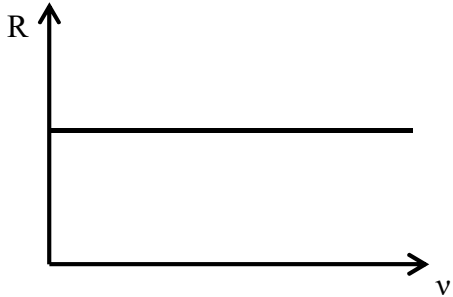
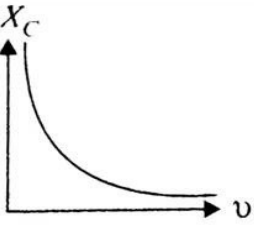
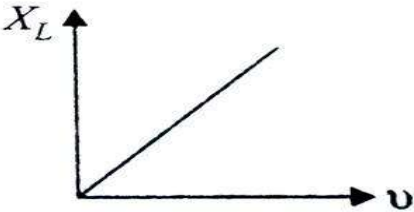
25.	<div style="border: 1px solid black; padding: 5px;"> <p>(a)</p> <p>(i) Graph showing variation of R with frequency $\frac{1}{2}$</p> <p>(ii) Graph showing variation of capacitive reactance with frequency $\frac{1}{2}$</p> <p>(iii) Graph showing variation of Inductive reactance with frequency $\frac{1}{2}$</p> <p>(b) Answer and Justification $\frac{1}{2} + 1$</p> </div> <p>(a) (i)</p>  <p>(ii)</p>  <p>(iii)</p> 	$\frac{1}{2}$	
-----	--	---------------	--

	(b) Yes, V_L and V_C can be greater than applied voltage. V_L and V_C are in opposite phase.	$\frac{1}{2}$ 1	3
26.	<div style="border: 1px solid black; padding: 5px; margin-bottom: 10px;"> <p>a) Stating two properties of a nucleus 1</p> <p>b) Why density of a nucleus is much more than that of an atom 1</p> <p>c) Showing that density of nuclear matter is same for all nuclei 1</p> </div> <p>a) (Any TWO)</p> <p>(i) The nucleus is positively charged</p> <p>(ii) The nucleus consists of protons and neutrons</p> <p>(iii) The nuclear density is independent of mass number</p> <p>(iv) The radius of the nucleus, $R = R_0 A^{1/3}$</p> <p>b) Atoms have large amount of empty spaces. Mass is concentrated in nucleus.</p> <p>c) Density = Mass / Volume</p> $= \frac{m A}{\frac{4}{3}\pi R^3} = \frac{m A}{\frac{4}{3}\pi R_0^3 A}$ $= \frac{m}{\frac{4}{3}\pi R_0^3}$ <p>So, density is independent of mass number.</p>	$\frac{1}{2} + \frac{1}{2}$ 1 1	3
27.	<div style="border: 1px solid black; padding: 5px; margin-bottom: 10px;"> <ul style="list-style-type: none"> • Statement of three postulates $\frac{1}{2} + \frac{1}{2} + \frac{1}{2}$ • Showing that frequency, $\nu \cong \frac{\alpha}{n^3}$ 1 $\frac{1}{2}$ </div> <p>Bohr's postulates:-</p> <p>(i) An electron in an atom could revolve in certain stable orbits without the emission of radiant energy.</p> <p>(ii) The electron revolves around the nucleus only in those orbits for which the angular momentum is some integral multiple of $h/2\pi$</p>		

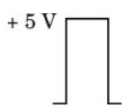

	<p>(iii) An electron might make a transition from one of its specified non-radiating orbits to another of lower energy. When it does so, a photon is emitted having energy equal to the energy difference between the initial and final states.</p> $h\nu = E_i - E_f \quad \text{----- (i)}$ $E_n \propto \frac{1}{n^2}$ $E_n - E_{n-1} = k \left[\frac{1}{(n-1)^2} - \frac{1}{n^2} \right]$ $= k \frac{n^2 - [n^2 + 1 - 2n]}{n^4 - 2n^3 + n^2}$ $= k \frac{2n - 1}{n^4 - 2n^3 + n^2}$ <p>For large n , $2n-1 \cong 2n$ $n^2 [n^2 - 2n+1] \cong n^4$</p> $E_n - E_{n-1} \cong k \frac{2n}{n^4} \cong \frac{2k}{n^3}$ <p>From equation (i) and (ii)</p> $\nu \cong \frac{\alpha}{n^3}$	<p>$\frac{1}{2} + \frac{1}{2} + \frac{1}{2}$</p> <p>$\frac{1}{2}$</p> <p>1</p>	<p>3</p>
28.	<div style="border: 1px solid black; padding: 5px; margin-bottom: 10px;"> <p>a) Two examples 1</p> <p>b) (i) Reason for use of short waves bands 1</p> <p style="padding-left: 20px;">(ii) Reason for x-ray astronomy from satellites 1</p> </div> <p>a) (Any Two)</p> <ul style="list-style-type: none"> • Gamma radiation having wavelength of 10^{-14} m to 10^{-15} m, typically originate from an atomic nucleus. • X-rays are emitted from heavy atoms. • Radio waves are produced by accelerating electrons in a circuit. A transmitting antenna can most efficiently radiate waves having a wavelength of about the same size as the antenna. <p>b) (i) Ionosphere reflects waves in these bands (ii) Atmosphere absorbs x-rays, while visible and radio waves can penetrate it</p> <p>Note: Full credit to be given for part (b) for mere attempt.</p>	<p>$\frac{1}{2} + \frac{1}{2}$</p> <p>1</p> <p>1</p>	<p>3</p>

<u>SECTION D</u>									
29.	(i) (A) $\frac{2(n-1)}{R}$ (ii) (D) P/2 (iii) (B) P (iv) a) (C) 2P OR b) (A) 6.6 D	1 1 1 1	4						
30.	(i) (A) $\frac{V_o}{\sqrt{2}}$ (ii) (B) half cycle of the input signal (iii) (C) One is forward biased and the other is reverse biased at the same time (iv) a) (B) 50 Hz OR b) (D) 	1 1 1 1	4						
<u>SECTION E</u>									
31.	(a) <table style="width: 100%; border-collapse: collapse;"> <tr> <td style="padding: 2px;">(i) Deriving expression for impedance</td> <td style="text-align: right; padding: 2px;">2</td> </tr> <tr> <td style="padding: 2px;">(ii) Reason</td> <td style="text-align: right; padding: 2px;">1</td> </tr> <tr> <td style="padding: 2px;">(iii) Inductance of coil</td> <td style="text-align: right; padding: 2px;">2</td> </tr> </table>	(i) Deriving expression for impedance	2	(ii) Reason	1	(iii) Inductance of coil	2		
(i) Deriving expression for impedance	2								
(ii) Reason	1								
(iii) Inductance of coil	2								

(i)

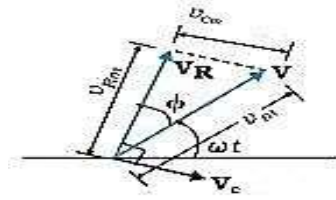

$$V_C + V_R = V$$

$$v_m^2 = v_{rm}^2 + v_{cm}^2$$

$$v_{rm} = i_m R$$

$$v_{cm} = i_m X_c$$

$$v_m^2 = (i_m R)^2 + (i_m X_c)^2$$
$$= i_m^2 [R^2 + X_c^2]$$

$$\Rightarrow i_m = \frac{v_m}{\sqrt{R^2 + X_c^2}}$$

$$\Rightarrow \text{Impedance } Z = \sqrt{R^2 + X_c^2}$$

(ii) For direct current (dc), an inductor behaves as a conductor.

$$\text{As } X_L = \omega L = 2\pi \nu L$$

$$\text{For dc } \nu = 0 \Rightarrow X_L = 0$$

Alternatively: -

$$\text{Induced emf } (\mathcal{E}) = - \frac{L dI}{dt}$$

$$\text{For dc; } dI = 0 \Rightarrow \mathcal{E} = 0$$

$$\text{(iii) } R = \frac{110}{11} = 10 \Omega$$

1/2

1/2

1/2

1/2

1

1/2

	$i_{rms} = \frac{v_{rms}}{\sqrt{R^2 + X_L^2}} = \frac{220}{\sqrt{100 + X_L^2}}$ $11 = \frac{220}{\sqrt{100 + X_L^2}}$ $\sqrt{100 + X_L^2} = \frac{220}{11} = 20\Omega$ <p>Squaring both sides:</p> $\Rightarrow 100 + X_L^2 = 400$ $\Rightarrow X_L^2 = 300 \Rightarrow X_L = 10\sqrt{3}\Omega$ $X_L = 2\pi fL \Rightarrow 10\sqrt{3} = 2\pi \times 50 \times L$ $L = \frac{\sqrt{3}}{10\pi} H$ <p style="text-align: center;">OR</p>	<p style="text-align: center;">$\frac{1}{2}$</p> <p style="text-align: center;">$\frac{1}{2}$</p> <p style="text-align: center;">$\frac{1}{2}$</p>													
	<p>(b)</p> <table border="1" style="width: 100%; border-collapse: collapse;"> <tbody> <tr> <td>(i) Labelled diagram of step – up transformer</td> <td style="text-align: right;">1</td> </tr> <tr> <td> Describing working principle</td> <td style="text-align: right;">$\frac{1}{2}$</td> </tr> <tr> <td> Three causes</td> <td style="text-align: right;">1 $\frac{1}{2}$</td> </tr> <tr> <td>(ii) Explanation</td> <td style="text-align: right;">1</td> </tr> <tr> <td>(iii) (1) Output voltage across secondary coil</td> <td style="text-align: right;">$\frac{1}{2}$</td> </tr> <tr> <td> (2) Current in primary coil</td> <td style="text-align: right;">$\frac{1}{2}$</td> </tr> </tbody> </table>	(i) Labelled diagram of step – up transformer	1	Describing working principle	$\frac{1}{2}$	Three causes	1 $\frac{1}{2}$	(ii) Explanation	1	(iii) (1) Output voltage across secondary coil	$\frac{1}{2}$	(2) Current in primary coil	$\frac{1}{2}$		
(i) Labelled diagram of step – up transformer	1														
Describing working principle	$\frac{1}{2}$														
Three causes	1 $\frac{1}{2}$														
(ii) Explanation	1														
(iii) (1) Output voltage across secondary coil	$\frac{1}{2}$														
(2) Current in primary coil	$\frac{1}{2}$														

(i)

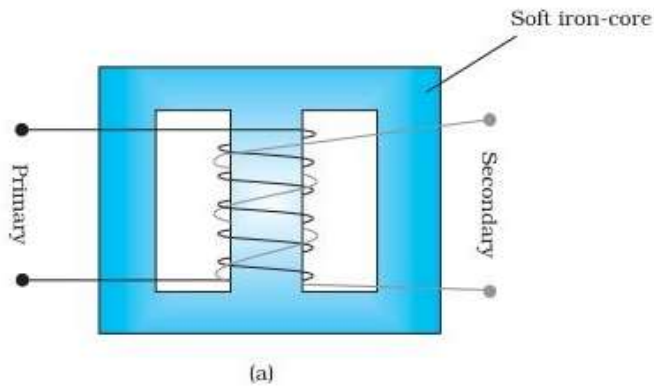

OR

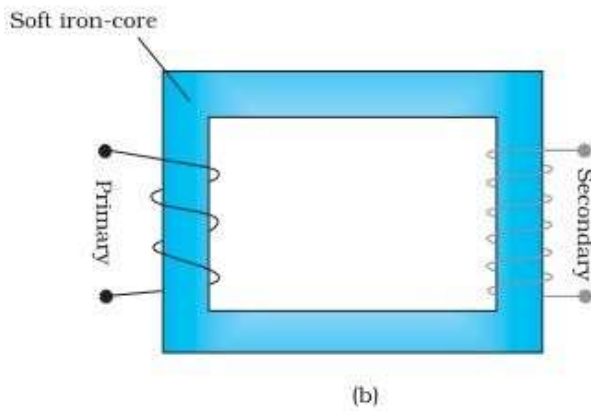

The working principle of transformer is mutual induction.

When an alternating voltage is applied to the primary, the resulting current produces an alternating magnetic flux which links the secondary and induces an emf in it.

Causes of energy losses (Any three)

- (a) Flux leakage
- (b) Resistance of the windings
- (c) Eddy currents
- (d) Hysteresis

1

$\frac{1}{2}$

$\frac{1}{2} + \frac{1}{2} + \frac{1}{2}$

(i)

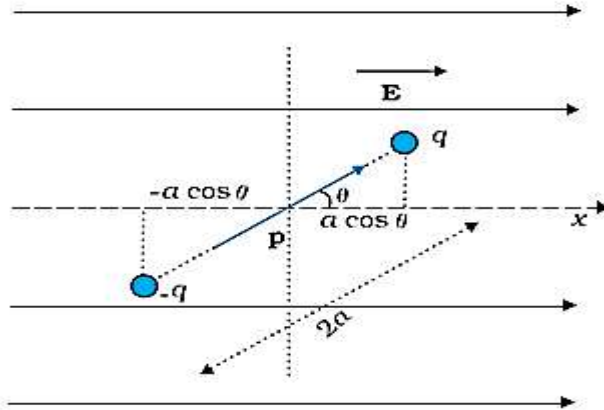

The amount of work done in rotating the dipole from $\theta = \theta_0$ to $\theta = \theta_1$ by the external torque

$$W = \int_{\theta_0}^{\theta_1} \tau_{ext} d\theta$$

$$= \int_{\theta_0}^{\theta_1} pE \sin \theta d\theta$$

$$W = pE(\cos \theta_0 - \cos \theta_1)$$

$$\text{For } \theta_0 = \frac{\pi}{2} \text{ \& } \theta_1 = \theta$$

$$= pE(\cos \frac{\pi}{2} - \cos \theta)$$

$$U(\theta) = -pE \cos \theta$$

$$= -\vec{p} \cdot \vec{E}$$

1/2

1/2

1/2

1/2

(1) Potential energy is maximum when:

\vec{p} is antiparallel to \vec{E}

Alternatively:

$$\theta = 180^\circ \text{ or } \pi \text{ radians}$$

(2) Potential energy is minimum when:

\vec{p} is along to \vec{E}

Alternatively:

$$\theta = 0^\circ$$

1/2

1/2

(ii)

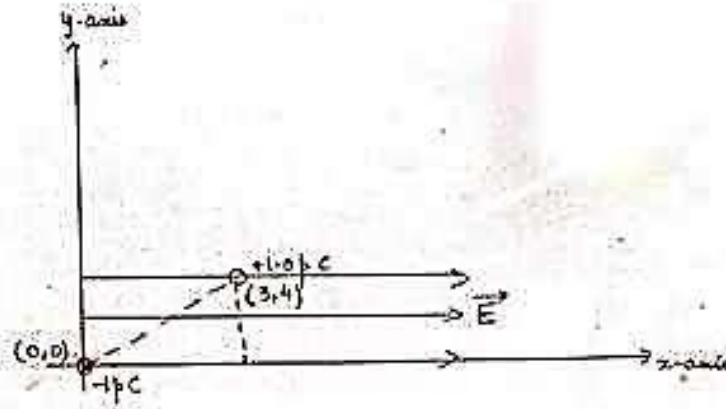

$$\begin{aligned}\tau &= pE \sin \theta \\ &= (2aq)E \sin \theta \\ &= (5 \times 10^{-3} \times 1 \times 10^{-12}) 10^3 \times \frac{4}{5} \\ &= 4 \times 10^{-12} \text{ Nm} \\ \text{Direction is along -ve Z direction.}\end{aligned}$$

½
½
½
½

OR

(b)

- | | |
|--|-----|
| (i) Deriving expression for potential | 2 ½ |
| (ii) New charge on Sphere S ₁ | 2 ½ |

(i)

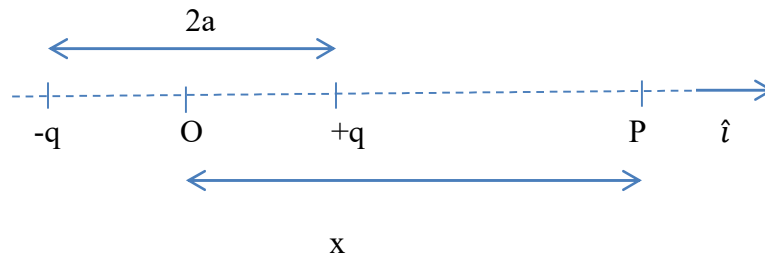

$$V = \frac{1}{4\pi\epsilon_0} \frac{q}{r}$$

$$V = V_{+q} - V_{-q}$$

$$V = \frac{1}{4\pi\epsilon_0} \left[\frac{q}{(x-a)} - \frac{q}{(x+a)} \right]$$

½
½
½

$$= \frac{q}{4\pi\epsilon_0} \left[\frac{x+a-x+a}{(x^2-a^2)} \right]$$

$$V = \frac{q}{4\pi\epsilon_0} \frac{2a}{(x^2-a^2)} = \frac{p}{4\pi\epsilon_0(x^2-a^2)}$$

As p is along x-axis, so

$$V = \frac{1}{4\pi\epsilon_0} \frac{\vec{p} \cdot \hat{i}}{(x^2-a^2)}$$

If $x \gg a$

$$V = \frac{1}{4\pi\epsilon_0} \frac{\vec{p} \cdot \hat{i}}{x^2}$$

Alternatively:

$$V = \frac{1}{4\pi\epsilon_0} \left(\frac{q}{r_1} - \frac{q}{r_2} \right) \quad \text{----- (i)}$$

By geometry

$$r_1^2 = r^2 + a^2 - 2ar \cos \theta$$

$$r_2^2 = r^2 + a^2 + 2ar \cos \theta$$

$$r_1^2 = r^2 \left(1 - \frac{2a \cos \theta}{r} + \frac{a^2}{r^2} \right)$$

$$\cong r^2 \left(1 - \frac{2a \cos \theta}{r} \right)$$

Similarly, $r_2^2 \cong r^2 \left(1 + \frac{2a \cos \theta}{r} \right)$

Using binomial theorem & retaining terms upto the first order in $\frac{a}{r}$; we

obtain

$\frac{1}{2}$

$\frac{1}{2}$

$\frac{1}{2}$

	$\frac{1}{r_1} \cong \frac{1}{r} \left(1 - \frac{2a \cos \theta}{r}\right)^{-\frac{1}{2}} \cong \frac{1}{r} \left(1 + \frac{a}{r} \cos \theta\right) \quad \text{----- (ii)}$ $\frac{1}{r_2} \cong \frac{1}{r} \left(1 - \frac{2a \cos \theta}{r}\right)^{-\frac{1}{2}} \cong \frac{1}{r} \left(1 - \frac{a}{r} \cos \theta\right) \quad \text{----- (iii)}$ <p>Using equations (i) ,(ii) & (iii) & p = 2qa</p> $V = \frac{q}{4\pi\epsilon_0} \frac{2a \cos \theta}{r^2} = \frac{p \cos \theta}{4\pi\epsilon_0 r^2}$ $p \cos \theta = \vec{p} \cdot \hat{r}$ <p>As \vec{r} is along the x – axis.</p> $\Rightarrow \vec{p} \cdot \hat{r} = \vec{p} \cdot \hat{i}$ $\Rightarrow V = \frac{1}{4\pi\epsilon_0} \frac{\vec{p} \cdot \hat{i}}{x^2}$	<p>1/2</p> <p>1/2</p> <p>1/2</p> <p>1/2</p>	
	<p>(ii)</p> <p>Charge on sphere S₁ :</p> $Q_1 = \text{surface charge density} \times \text{surface Area}$ $= \left(\frac{2}{\pi} \times 10^{-9}\right) \times 4\pi (1 \times 10^{-2})^2$ $= 8 \times 10^{-13} \text{ C}$ <p>Charge on sphere S₂ :</p> $Q_2 = \text{surface charge density} \times \text{surface Area}$ $= \left(\frac{2}{\pi} \times 10^{-9}\right) \times 4\pi (3 \times 10^{-2})^2$ $= 72 \times 10^{-13} \text{ C}$	<p>1/2</p> <p>1/2</p>	

When connected by a thin wire they acquire a common potential V and the charge remains conserved.

$$Q_1 + Q_2 = Q'_1 + Q'_2$$

$$= C_1V + C_2V$$

$$Q_1 + Q_2 = (C_1 + C_2)V$$

$$\text{Common potential}(V) = \frac{Q_1 + Q_2}{C_1 + C_2}$$

$$C_1 = 4\pi\epsilon_0 r_1 = \frac{1}{9 \times 10^9} \times 10^{-2} = \frac{1}{9} \times 10^{-11} F$$

$$C_2 = 4\pi\epsilon_0 r_2 = \frac{1}{9 \times 10^9} \times 3 \times 10^{-2} = \frac{1}{3} \times 10^{-11} F$$

$$V = \frac{80 \times 10^{-13}}{\left(\frac{1}{9} + \frac{1}{3}\right) \times 10^{-11}} = 1.8 V$$

$$Q'_1 = C_1V = \frac{1}{9} \times 10^{-11} \times 1.8$$

$$Q'_1 = 2 \times 10^{-12} C$$

Alternatively:

Charge on sphere S_1 :

$$Q_1 = \text{surface charge density} \times \text{surface Area}$$

$$= \left(\frac{2}{\pi} \times 10^{-9}\right) \times 4\pi(1 \times 10^{-2})^2$$

$$= 8 \times 10^{-13} C$$

Charge on sphere S_2 :

$$Q_2 = \text{surface charge density} \times \text{surface Area}$$

$$= \left(\frac{2}{\pi} \times 10^{-9}\right) \times 4\pi(3 \times 10^{-2})^2$$

$$= 72 \times 10^{-13} C$$

$\frac{1}{2}$

$\frac{1}{2}$

$\frac{1}{2}$

$\frac{1}{2}$

$\frac{1}{2}$

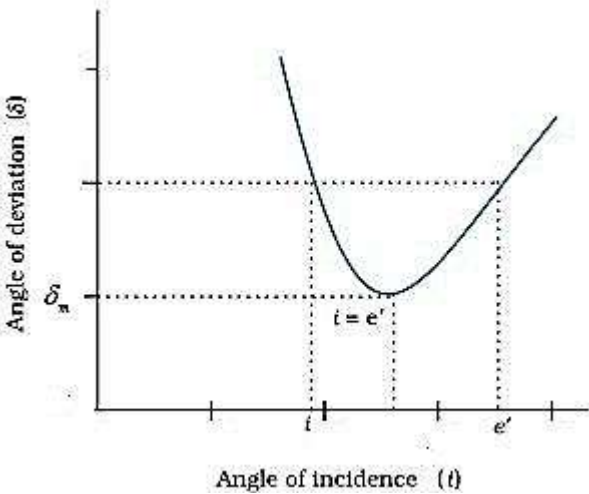

	<p>When connected by a thin wire they acquire a common potential V and the charge remains conserved.</p> $Q_1 + Q_2 = Q'_1 + Q'_2$ $\frac{Q'_2}{Q'_1} = \frac{r_2}{r_1}$ <p>On solving, $Q'_1 = 2 \times 10^{-12} \text{ C}$</p>	<p>$\frac{1}{2}$</p> <p>$\frac{1}{2}$</p> <p>$\frac{1}{2}$</p>	<p>5</p>										
<p>33.</p>	<p>(a)</p> <table border="1" data-bbox="250 653 1208 1073"> <tr> <td>(i) Graph showing variation of angle of deviation with angle of incidence</td> <td>1</td> </tr> <tr> <td> Defining angle of minimum deviation</td> <td>1</td> </tr> <tr> <td>(ii) Proof of refractive index $n = \frac{\sin(A + \delta)}{\sin A}$</td> <td>1</td> </tr> <tr> <td>(iii) (1) Finding angle of minimum deviation</td> <td>1</td> </tr> <tr> <td> (2) Angle of Incidence</td> <td>1</td> </tr> </table> <p>(i)</p> 	(i) Graph showing variation of angle of deviation with angle of incidence	1	Defining angle of minimum deviation	1	(ii) Proof of refractive index $n = \frac{\sin(A + \delta)}{\sin A}$	1	(iii) (1) Finding angle of minimum deviation	1	(2) Angle of Incidence	1	<p>1</p>	
(i) Graph showing variation of angle of deviation with angle of incidence	1												
Defining angle of minimum deviation	1												
(ii) Proof of refractive index $n = \frac{\sin(A + \delta)}{\sin A}$	1												
(iii) (1) Finding angle of minimum deviation	1												
(2) Angle of Incidence	1												

Minimum deviation angle is defined as the angle at which angle of incidence is equal to the angle of emergence.

Alternatively

At minimum deviation refracted ray inside the prism becomes parallel to the base of the prism.

(ii)

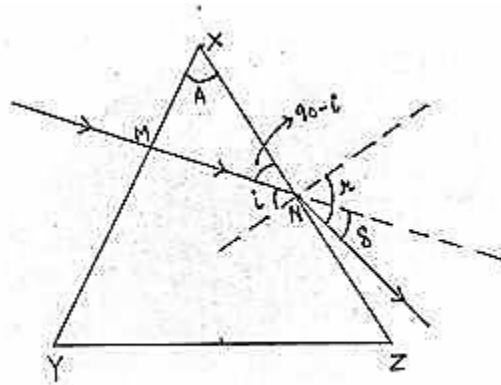

At the face XZ :-

$$\mu \sin i = 1 \times \sin r \quad \text{----- (1)}$$

$$r = i + \delta \quad \text{[from diagram]} \quad \text{----- (2)}$$

$$\text{In } \triangle XMN; \quad A + (90 - i) + 90 = 180$$

$$\Rightarrow A = i \quad \text{----- (3)}$$

Putting eq. (3) & (2) in eq. (1)

$$\mu \sin A = \sin (A + \delta)$$

$$\mu = \frac{\sin (A + \delta)}{\sin A}$$

(iii)

$$(1) \quad \mu = \frac{\sin \left(\frac{A + \delta_m}{2} \right)}{\sin \frac{A}{2}}$$

$$\sqrt{2} = \frac{\sin \left(\frac{60 + \delta_m}{2} \right)}{\sin 30^\circ}$$

$$\Rightarrow \sin \left(\frac{60 + \delta_m}{2} \right) = \frac{1}{\sqrt{2}} = \sin 45^\circ$$

$$\frac{60 + \delta_m}{2} = 45^\circ \Rightarrow \delta_m = 30^\circ$$

1

1/2

1/2

1/2

1/2

	<p>(2) $i = \frac{A + \delta_m}{2}$ $\Rightarrow i = \frac{60 + 30}{2}$ $i = 45^\circ$</p> <p style="text-align: center;">OR</p>	<p>$\frac{1}{2}$</p> <p>$\frac{1}{2}$</p>													
	<p>(b)</p> <table border="1" style="width: 100%; border-collapse: collapse;"> <tr> <td style="padding: 5px;">(i) Statement of Huygens' Principle</td> <td style="text-align: right; padding: 5px;">$\frac{1}{2}$</td> </tr> <tr> <td style="padding: 5px;">Construction of reflected wave front</td> <td style="text-align: right; padding: 5px;">$\frac{1}{2}$</td> </tr> <tr> <td style="padding: 5px;">Proof of angle of reflection is equal to angle of incidence</td> <td style="text-align: right; padding: 5px;">1</td> </tr> <tr> <td style="padding: 5px;">(ii) Definition of coherent sources</td> <td style="text-align: right; padding: 5px;">$\frac{1}{2}$</td> </tr> <tr> <td style="padding: 5px;">Explanation</td> <td style="text-align: right; padding: 5px;">1</td> </tr> <tr> <td style="padding: 5px;">(iii) Finding the unknown wavelength</td> <td style="text-align: right; padding: 5px;">1 $\frac{1}{2}$</td> </tr> </table> <p>(i) Each point of the wavefront is the source of a secondary disturbance and the wavelets emanating from these points spread out in all directions with the spread of the wave. Each point of the wavefront is the source of a secondary disturbance and the wavelets emanating from these points spread out in all directions with the speed of the wave. These wavelets emanating from the wavefront are usually referred to as secondary wavelets and if we draw a common tangent to all these spheres, we obtain the new position of the wavefront at a later time.</p> <div style="text-align: center;"> </div> <p>ΔEAC is congruent to ΔBAC; so $\angle i = \angle r$</p> <p>(ii) Two sources are said to be coherent if the phase difference between them does not change with time.</p> <p>No, two independent sodium lamps cannot be coherent. Two independent sodium lamps cannot be coherent as the phase between them does not remain constant with time.</p>	(i) Statement of Huygens' Principle	$\frac{1}{2}$	Construction of reflected wave front	$\frac{1}{2}$	Proof of angle of reflection is equal to angle of incidence	1	(ii) Definition of coherent sources	$\frac{1}{2}$	Explanation	1	(iii) Finding the unknown wavelength	1 $\frac{1}{2}$	<p>$\frac{1}{2}$</p> <p>$\frac{1}{2}$</p> <p>1</p> <p>$\frac{1}{2}$</p> <p>$\frac{1}{2}$</p> <p>$\frac{1}{2}$</p>	
(i) Statement of Huygens' Principle	$\frac{1}{2}$														
Construction of reflected wave front	$\frac{1}{2}$														
Proof of angle of reflection is equal to angle of incidence	1														
(ii) Definition of coherent sources	$\frac{1}{2}$														
Explanation	1														
(iii) Finding the unknown wavelength	1 $\frac{1}{2}$														

